

9387-FB-Px-R

***5-spur, Open Frame,
Redundant Fieldbus Barrier***



Instruction Manual

INM9380-RD



DECLARATION OF CONFORMITY

We declare under our sole responsibility that the MTL937x-FB-Px-xx systems, 938x-FB-xx internal assemblies and associated products listed in Annex 1 overleaf, to which this declaration relates, conform with the requirements of the Directives below by compliance with the standards listed:

1. Council Directive 2004/108/EC (EMC Directive) relating to Electro-Magnetic Compatibility.
EN 61326-1:2006
Table 2 - Industrial Locations: Class A equipment
2. Council Directive 2006/95/EC (Low Voltage Directive) relating to Product Safety.
EN 61010-1:2010
3. Council Directive 94/9/EC (ATEX Directive) relating to equipment and protective systems intended for use in potentially explosive atmospheres.
EN 60079-0:2009; EN 60079-1:2007; EN 60079-7:2007; EN 60079-11:2007; EN 60079-18:2009;
EN 60079-27:2008; EN 60079-18:2004; EN 60079-27:2006; IEC60079-31:2008

3rd May 2012

Luton, England

 **COOPER** Crouse-Hinds

Signed: *J.N. Malins*
J.N.Malins - Technical Director

 **MTL
Instruments**
Measurement Technology Limited
Great Marlings, Butterfield, Luton
Bedfordshire, United Kingdom LU2 8DL
Tel: +44 (0)1582 723633
Fax: +44 (0)1582 422283
www.mtl-inst.com
Registered in England No. 1012778

Annex 1 - Conforming Products

Product	Description	EMC ¹	LVD ²	ATEX ³	Cat1/Cat2 ATEX Cert No.	Cat2 ATEX Cert No.
9371-FB-PS-SS	Fieldbus barrier system, 6-spur, stainless steel enclosure, pluggable screw terminal connectors	Yes	Yes	Yes	Baseefa 09 ATEX 0185X/3#	N/A
9371-FB-PC-SS	Fieldbus barrier system, 6-spur, stainless steel enclosure, pluggable spring clamp connectors	Yes	Yes	Yes	Baseefa 09 ATEX 0185X/3#	N/A
9373-FB-PS-SS	Fieldbus barrier system, 12-spur, stainless steel enclosure, pluggable screw terminal connectors	Yes	Yes	Yes	Baseefa 09 ATEX 0185X/3#	N/A
9373-FB-PC-SS	Fieldbus barrier system, 12-spur, stainless steel enclosure, pluggable spring clamp connectors	Yes	Yes	Yes	Baseefa 09 ATEX 0185X/3#	N/A
9371-FB-PS-PP	Fieldbus barrier system, 6-spur, GRP enclosure, pluggable screw terminal connectors	Yes	Yes	Yes	Baseefa 09 ATEX 0185X/3#	N/A
9371-FB-PC-PP	Fieldbus barrier system, 6-spur, GRP enclosure, pluggable spring clamp connectors	Yes	Yes	Yes	Baseefa 09 ATEX 0185X/3#	N/A
9373-FB-PS-PP	Fieldbus barrier system, 12-spur, GRP enclosure, pluggable screw terminal connectors	Yes	Yes	Yes	Baseefa 09 ATEX 0185X/3#	N/A
9373-FB-PC-PP	Fieldbus barrier system, 12-spur, GRP enclosure, pluggable spring clamp connectors	Yes	Yes	Yes	Baseefa 09 ATEX 0185X/3#	N/A
9371/4-FB-PS-SS	Fieldbus barrier system, 4-spur, stainless steel enclosure, pluggable screw terminal connectors	Yes	Yes	Yes	Baseefa 09 ATEX 0185X/1	N/A
9371/4-FB-PC-SS	Fieldbus barrier system, 4-spur, stainless steel enclosure, pluggable spring clamp connectors	Yes	Yes	Yes	Baseefa 09 ATEX 0185X/1	N/A
9373/8-FB-PS-SS	Fieldbus barrier system, 8-spur, stainless steel enclosure, pluggable screw terminal connectors	Yes	Yes	Yes	Baseefa 09 ATEX 0185X/1	N/A
9373/8-FB-PC-SS	Fieldbus barrier system, 8-spur, stainless steel enclosure, pluggable spring clamp connectors	Yes	Yes	Yes	Baseefa 09 ATEX 0185X/1	N/A
9371/4-FB-PS-PP	Fieldbus barrier system, 4-spur, GRP enclosure, pluggable screw terminal connectors	Yes	Yes	Yes	Baseefa 09 ATEX 0185X/1	N/A
9371/4-FB-PC-PP	Fieldbus barrier system, 4-spur, GRP enclosure, pluggable spring clamp connectors	Yes	Yes	Yes	Baseefa 09 ATEX 0185X/1	N/A
9373/8-FB-PS-PP	Fieldbus barrier system, 8-spur, GRP enclosure, pluggable screw terminal connectors	Yes	Yes	Yes	Baseefa 09 ATEX 0185X/1	N/A
9373/8-FB-PC-PP	Fieldbus barrier system, 8-spur, GRP enclosure, pluggable spring clamp connectors	Yes	Yes	Yes	Baseefa 09 ATEX 0185X/1	N/A
9376-SP	Trunk surge module	Yes	Yes	Yes	Baseefa 09 ATEX 0324U#	N/A
9378-FT	Trunk terminator module	Yes	Yes	Yes	Baseefa 09 ATEX 0323U#	N/A
9387-FB-PS	Fieldbus barrier internal assembly, 6-spur, pluggable screw terminal connectors	Yes	Yes	Yes	Baseefa 09 ATEX 0184U*#	N/A
9387-FB-PC	Fieldbus barrier internal assembly, 6-spur, pluggable spring clamp connectors	Yes	Yes	Yes	Baseefa 09 ATEX 0184U*#	N/A
9388-FB-PS	Fieldbus barrier internal assembly, 12-spur, pluggable screw terminal connectors	Yes	Yes	Yes	Baseefa 09 ATEX 0184U*#	N/A
9388-FB-PC	Fieldbus barrier internal assembly, 12-spur, pluggable spring clamp connectors	Yes	Yes	Yes	Baseefa 09 ATEX 0184U*#	N/A
9387-FB-PS-R	Fieldbus barrier redundant internal assembly, pluggable screw terminal connectors	Yes	Yes	Yes	Baseefa 09 ATEX 0184U*#	N/A
9387-FB-PC-R	Fieldbus barrier redundant internal assembly, pluggable spring clamp connectors	Yes	Yes	Yes	Baseefa 09 ATEX 0184U*#	N/A
9372-FB-PS-SS	Fieldbus barrier redundant, stainless steel enclosure, pluggable screw terminal connectors	Yes	Yes	Yes	Baseefa 09 ATEX 0185X/3#	N/A
9372-FB-PC-SS	Fieldbus barrier redundant, stainless steel enclosure, pluggable spring clamp connectors	Yes	Yes	Yes	Baseefa 09 ATEX 0185X/3#	N/A
9372-FB-PS-PP	Fieldbus barrier redundant, GRP enclosure, pluggable screw terminal connectors	Yes	Yes	Yes	Baseefa 09 ATEX 0185X/3#	N/A
9372-FB-PC-PP	Fieldbus barrier redundant, GRP enclosure, pluggable spring clamp connectors	Yes	Yes	Yes	Baseefa 09 ATEX 0185X/3#	N/A

* For products highlighted with a *, IEC60079-31:2008 does not apply

Products highlighted with a #, have been tested to EN 60079-18:2009 and EN 60079-27:2008

Notes relating to CE Marking:

- Entries in this column may be:
Yes Product conforms to the EMC Directive
N/R Product is not required to conform to the EMC Directive
- Entries in this column may be:
Yes Product conforms to the EMC Directive
N/R Product is not required to conform to the EMC Directive
- Entries in this column may be:
Yes Product conforms to the ATEX Directive
N/R Product is not required to conform to the ATEX Directive

4 All items equipment group II, category 2, gas group IIC

Notified Body responsible for Cat I or 2 ATEX Certificates:

Baseefa, Rockhead Business Park, Staden Lane, Buxton, Derbyshire, SK 17 9RZ. Notified body number 1180.



CONTENTS

1	OVERVIEW	1
2	DESCRIPTION	2
2.1	General	2
2.2	Configuration options	2
2.3	Trunk Terminal Assembly	3
3	MECHANICAL INSTALLATION	3
3.1	Mounting overview	3
3.2	Preparation	4
3.3	Mounting the assembly in a suitable enclosure	4
4	INITIAL ELECTRICAL INSTALLATION	5
4.1	Overview	5
4.2	Grounding	5
4.3	Trunk connections	8
4.4	Trunk Terminator module 9378-FT	10
4.5	Trunk Surge module 9376-SP	10
4.6	Spur connections	10
4.7	Final checks	11
5	MAINTENANCE	12
5.1	General	12
5.2	Fieldbus Barrier maintenance procedures	12
5.3	Spur connections	15
5.4	Trunk connections	16
5.5	Regular Maintenance checks	16
6	TROUBLESHOOTING	17
7	ALARM MODULE - OPERATION & CONFIGURATION	18
7.1	Introduction	18
7.2	Device details	18
7.3	Alarm module fitting or replacement	19
8	ATEX INFORMATION	21
8.1	General	21
8.2	Installation	21
8.3	Inspection and maintenance	22
8.4	Repair	22
8.5	Marking	22
9	APPENDIX 1 - ENCLOSURE WIRING DIAGRAM	23

GENERAL SAFETY INFORMATION

Safety instructions for installation and operating personnel

The operating instructions provided here contain **essential safety instructions** for installation personnel and those engaged in the operation, maintenance and servicing of the equipment.

	WARNING!
	Failure to comply with these instructions can endanger the lives or health of personnel and risk damage to the plant and the environment.
	WARNING!
	The responsibility for planning, installation, commissioning, operation and maintenance, particularly with respect to applications in explosion-hazard areas, lies with the plant operator.

Before commencing installation or commissioning:

- Read and understand the contents of this manual
- Ensure installation and operating personnel have received adequate training for this task
- Ensure that any operating instructions are fully understood by the personnel responsible.
- Observe national and local installation and mounting regulations (e.g. IEC 60079-14).

	WARNING!
	These assemblies may not be used in explosion-hazard area applications if they have been used previously in general electrical installations.

During operation:

- Make the relevant instructions available at all times to the operating personnel.
- Observe safety instructions.
- Observe national safety and accident prevention regulations.
- Operate the equipment within its published specification.
- Servicing, maintenance work or repairs not described in this manual must not be performed without prior agreement with the manufacturer.
- Any damage to this equipment may render its explosion protection null and void.
- No changes to any of the components that might impair their explosion protection are permitted.

If any information provided here is not clear:

- Contact MTL or one of its representatives.

Note: Improper installation and operation of the enclosure can result in the invalidation of the guarantee.

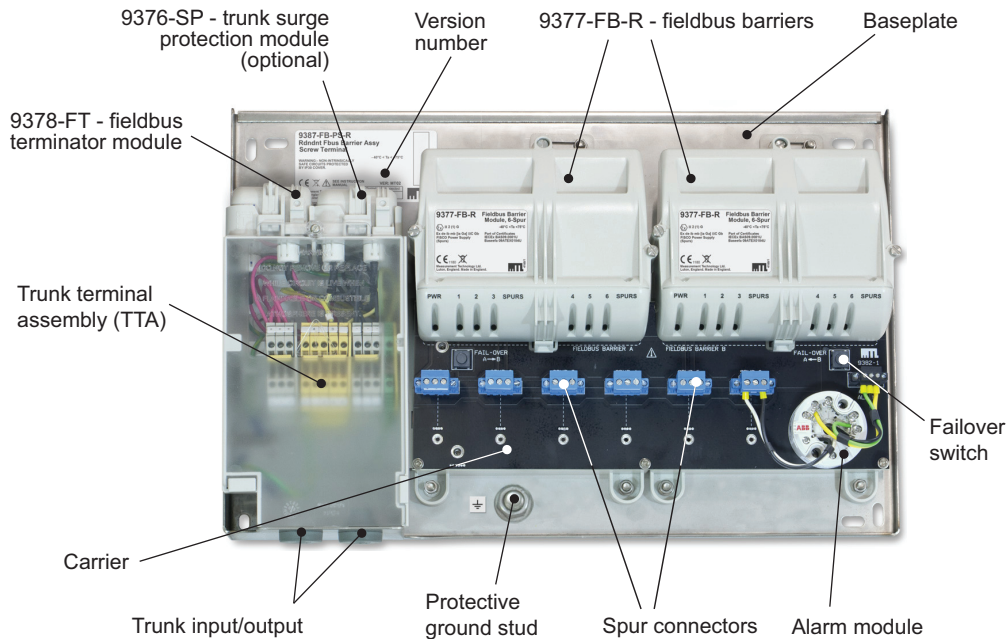

Figure 1.1 - Example of model 9387-FB-Px-R

1 OVERVIEW

This manual explains the installation and maintenance procedures for the 9387-FB-Px-R Open-Frame Redundant Fieldbus Barrier and must be read in association with the product datasheet that contains the electrical data.

The 9387-FB-Px-R assembly is a wiring hub that creates five* intrinsically safe spur connections from a high-energy trunk, for connection to suitably certified FOUNDATION™ fieldbus H1 instruments. The assembly is bus-powered and requires no additional power supply in the field.

When installed and certified inside a suitable Ex enclosure (see Section 3.1 on page 3), an assembly may be installed in a Zone 1 or a Zone 2 hazardous area.

Each assembly uses a pair of Fieldbus Barrier modules in a “redundant spur” configuration in order to achieve significantly higher system availability than equivalent ‘simplex’ units. The 9387-FB-Px-R may therefore be selected for critical process applications where failure of the Fieldbus Barrier would otherwise result in unacceptable downtime or lost production. It is also ideal for use in fieldbus Safety Instrumented Function (SIF) networks in which nuisance trips cannot be tolerated. Failure annunciation to the host control system is provided by means of an integrated FOUNDATION™ fieldbus device with Digital Input Function Block capability.

The baseplate on which the carrier and trunk terminal assembly is mounted is 316 stainless steel for protection against corrosion.

The following types are available by ordering the appropriate model number.

9387-FB-Px-R Redundant Fieldbus Barrier assembly, 5-spur

Where Px = PS (pluggable screw terminal connectors) or
PC (pluggable spring clamp connectors)

* See section 2.2

2 DESCRIPTION

2.1 General

The assembly consists of a stainless steel baseplate, together with a trunk-wiring terminal assembly (TTA), two carrier-mounted fieldbus barriers and a fieldbus alarm module. Each barrier module can convert a single, non-intrinsically safe fieldbus trunk into six, galvanically isolated, intrinsically safe (IS) spur connections for connection to FOUNDATION™ fieldbus H1 fieldbus instruments. However, *only six spurs are available at any one time* because they are configured as “redundant pairs”. On power-up the spurs in one barrier are configured to be in “active” mode, while the spurs in the other barrier remain in “standby”. In the event of a spur circuit failure in the “active” barrier module, an automatic switchover ensures that the external spur field circuit *continues to be supported* by the corresponding spur in the “standby” module.

Figure 2.1 illustrates an example where Module A - on the left - is the active barrier and Module B the standby. Spurs 1,2, 4, 5 and 6 of Module A are shown as active ('A') but spur 3 has failed (and effectively gone into standby) so module B has automatically taken control of spur 3 ('A') to maintain full service to the affected field circuit.

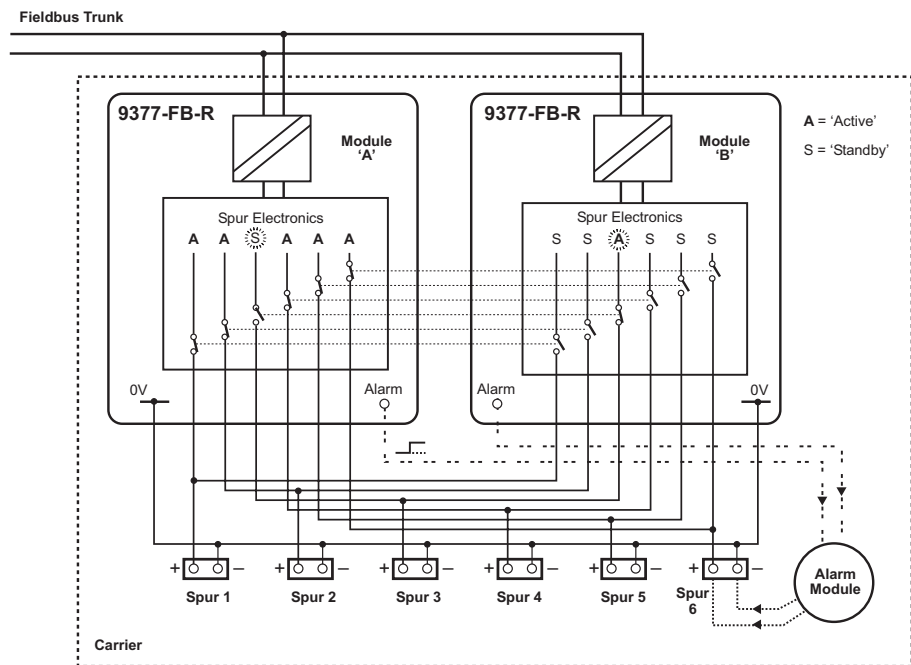

Figure 2.1 - Redundant spurs block diagram + optional alarm module

The spurs are galvanically isolated from the trunk allowing the user to choose the type of grounding scheme most suitable to their system.

Spur short-circuit protection is provided by the barrier and surge protection can also be added on individual outgoing spurs by the use of individual Spur Surge protection modules (part no. FS32).

The baseplates are supplied pre-drilled for mounting on any surface capable of supporting the assemblies.

2.2 Configuration options

There are six spur outputs from each barrier and, as described above, these can operate in a redundant fashion, supporting each other to maintain continuous availability. However, if a spur “fails-over” to the other barrier, the situation might go undetected without frequent inspection of the status of the barrier LEDs. For this reason, a “failure-reporting” configuration is provided, where Spur 6 is assigned to an internally located Alarm Module (model 9379-ALM) - see Figure 2.1.

Consequently, if a spur 'fail-over' occurs, an alarm is signalled quickly to the host, via the fieldbus connection, to facilitate any necessary remedial action. The five remaining spurs are available to the user for connection to field devices.

2.3 Trunk Terminal Assembly

The incoming trunk wiring is terminated inside a separate compartment, called the Trunk Terminal Assembly (TTA), that contains increased safety (Ex e) trunk wiring terminals. This compartment has a protective cover to deter interference, and carries a warning to the user about working on trunk wiring without first isolating the power. A fieldbus Terminator module (part no. 9378-FT) is supplied pre-fitted on the TTA. This is to remain installed if the assembly is at the end of the segment. If the incoming fieldbus trunk will be onward linked to a further node on the segment the terminator can be removed. See Section 4.4 on page 10 for additional information.

An optional Trunk Surge module (part no. 9376-SP) can be plugged into the TTA to protect the fieldbus barrier against damaging voltage and current surges on the incoming trunk wiring.

The 9387-FB-Px-R Fieldbus Barriers are bus-powered and require no additional power supply in the field. When used with a fieldbus host control system, power for the trunk **MUST** be provided only by a supply conforming to IEC 61158-2, e.g. MTL-Relcom F800 or 918x Series redundant power supplies.

3 MECHANICAL INSTALLATION

See Figure 3.1 for the dimensions, fixing locations and cable gland positions.

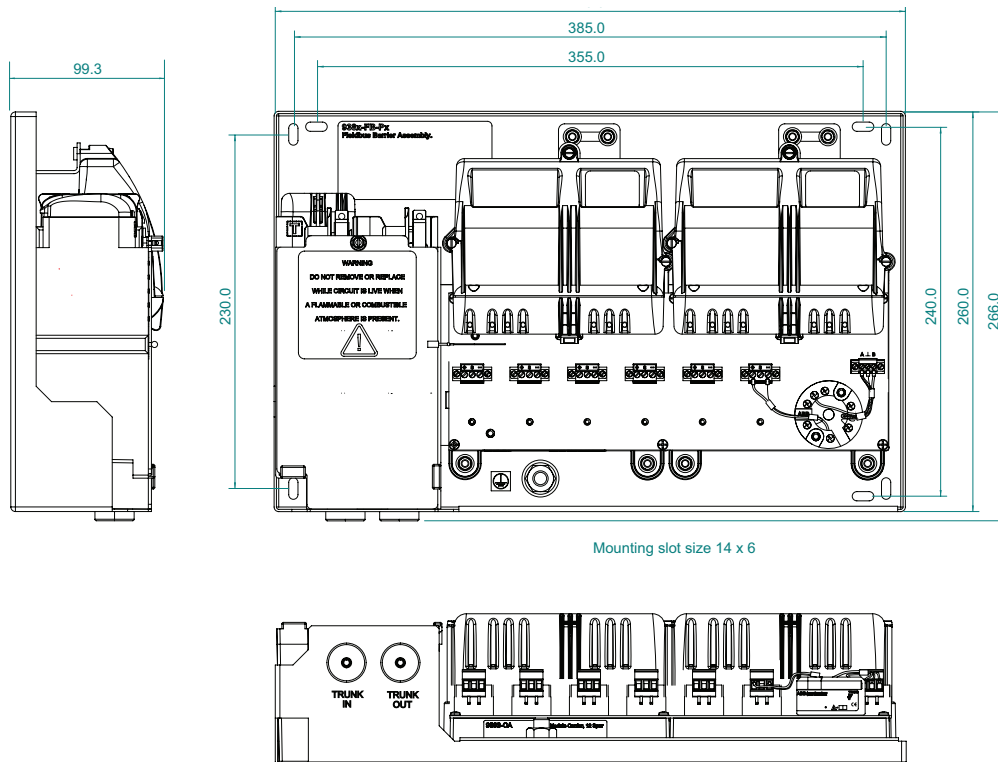

Figure 3.1 - Dimensions and mounting hole positions for the assembly (9387-FB-Px-R)

3.1 Mounting overview

Before mounting an assembly, consider the following points.

- When planning the layout of any protective enclosure for an assembly, ensure that adequate space is provided for suitable cable management (e.g. trunking).
- The permitted ambient temperature range for the assembly (-40°C to $+75^{\circ}\text{C}$) must not be exceeded. Avoid radiant heat by positioning an assembly and its enclosure away from direct sunlight or local sources of heat.

- c) An assembly has limited ingress protection and **must be provided with protection appropriate to the environment** in which it is located. The following table provides guidance on minimum environmental protection for specific locations.

Location	Minimum environmental protection
Safe area	IP20
Zone 1 or Zone 2	Ex e or Ex d certified enclosure; \geq IP54 - increase level for more severe conditions

Note: For installation in Zone 1 or 2, the combination of a 9387-FB-Px-R open frame assembly and its protective Ex e or Ex d enclosure **will require certification as a complete assembly** by a third-party certifying authority.

- d) An assembly will provide the best thermal performance when mounted on a vertical surface. Other orientations are possible but may require some de-rating of the permitted operating temperature range.
- e) Adequate security should be provided against unauthorised interference with the equipment.
- f) If the chosen protective enclosure is liable to encounter significant levels of condensation, it is advisable to incorporate a drain/breather to minimise moisture accumulation.

3.2 Preparation

NOTE: The weight of an assembly must be considered when choosing a suitable mounting location. Use the following figures for guidance.

Assembly/Component	Guide weight (kg)
Baseplate, carriers and TTA (no modules)	2.8
Fieldbus barrier module 9377-FB-R	0.95
Alarm module 9379-ALM (including connectors)	0.07
Trunk terminator module (max. 1 per assembly)	0.12
Trunk surge suppressor module (max. 1 per assembly)	0.16
Spur surge suppressor module (max. 1 per spur)	0.04

- a) Remove any temporary protection or packing materials.
- b) The assembly can be mounted on any suitable structure via the mounting holes in the corners - see Figure 3.1 for details.
- c) All fixings must be suitable for the mounting surface and the environmental conditions that are likely to be encountered.

3.3 Mounting the assembly in a suitable enclosure

WARNING!	
	<p>To minimise the risk of ignition by electrical apparatus in hazardous areas, efficient installation, inspection and maintenance of apparatus and systems is essential, and the work should be carried out by suitably trained personnel in accordance with the prevailing code of practice.</p> <p>The certification documents specify "Conditions for safe use" that must be adhered to and the copy certificate supplied should be studied and understood. Additionally it is recommend that a working knowledge of IEC EN 60079 -14 be attained, as this standard provides guidance in respect to the installation of electrical equipment in hazardous areas.</p>

3.3.1 Fixing the assembly

Either define hole or stud positions based upon the dimensions given in Figures 3.1, or use the baseplate as a template. Prepare the fixings being used, then attach the assembly.

After mounting the assembly

Check that:

- none of the component parts have suffered any damage,
- the baseplate of the assembly is not distorted
- the mounting bolts/nuts are all tightened as recommended above.

4 INITIAL ELECTRICAL INSTALLATION

	WARNING!
	Before starting any electrical installation work, ensure that the incoming trunk connection is isolated from any source of power.

CAUTION
Assembly temperatures could rise to 75°C. Ensure that all cables and cable glands fitted are rated to withstand these temperatures.

4.1 Overview

- The assembly receives power from the incoming trunk cable and requires no further source of power.
- It shall only be powered from supplies conforming to IEC 61158.
- **The environment/enclosure in which an assembly is mounted must ensure adequate separation of the trunk and spur wiring.** This may be provided by means of separate cable trunking or clear physical separation as defined by local rules. Blue cable trunking is recommended for the IS spur cables to identify that they are intrinsically safe circuits, while grey or black trunking is recommended for the non-IS trunk cables. The cable routing should ensure that trunk and spur cables do not cross each other inside the enclosure.
- Type 'A' fieldbus cable is recommended for fieldbus trunk connections.
- The TTA can accommodate trunk cables with outer diameters between approximately 5 and 13mm - see Section 4.3.1 for further details regarding protection rating.
- The terminal blocks for the trunk fieldbus cables have either screw terminal connectors or cage clamp connectors according to the model specified, but both are suitable for cables from 0.5mm²/AWG 20 up to 2.5mm²/AWG 14.

For details of the wiring for the two system types see Appendix 1.

4.2 Grounding

Two distinct ground concepts should be recognised before wiring of the assembly begins:

- a) Protective local ground - mandatory
- b) Cable shield ground

These two concepts and their implementation are explained below.

4.2.1 Protective local ground

This ground connection is required to ensure that any exposed metalwork of the assembly does not present a hazard to personnel; it also provides a low impedance earth grounding circuit for any surge protection items used on the assembly. An M10 earth-grounding stud is provided on the assembly baseplate, which must be bonded to the body of any protective enclosure and from there to the local plant structure.

Where multiple assemblies are installed inside one final enclosure, the grounding studs for the individual baseplate must be connected in a "star" formation to the grounding point on the enclosure.

Note: It is important to prevent these connections from loosening and also to protect them from corrosion against the stainless steel grounding stud.

4.2.2 Cable shield ground

The cable shield is normally electrically isolated from the protective earth ground, although the two may be deliberately interconnected in some grounding arrangements. The cable shield wiring of both the trunk and spur cables should be connected to the local terminals marked with an 'S'.

	WARNING!
	<p>The following may involve changes to wiring in the Trunk Terminal Assembly. No part of the Trunk Terminal Assembly may be worked while the enclosure is powered, unless the environment is known to be non-hazardous.</p>

The user has the option of two grounding methods for the assembly; the one adopted should be the one that conforms to the system's *normal* grounding method.

Whichever method is used, it is important to connect the screen/shield to a ground at only one end of the cable.

The following options are available to the user.

4.2.2.1 Single point of grounding at host; trunk & spur shields interconnected

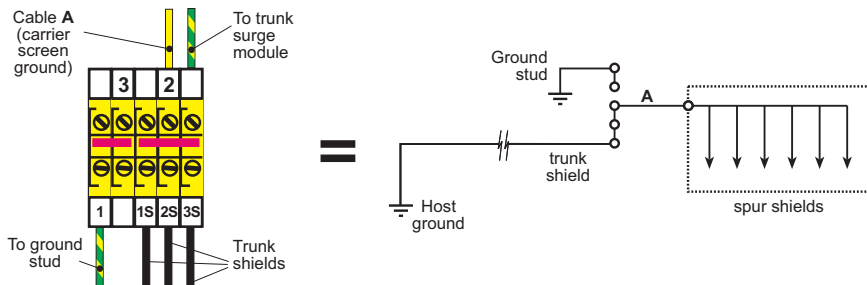

Figure 4.1 - Option 1

In many installations, the preferred method of grounding is to ground the fieldbus cable shields at one point only, normally at the fieldbus power supply. In this case, the trunk and spur cable shields are connected to each other at the Fieldbus Barrier and are not connected to ground in the field. For this arrangement, connect the carrier shield ground wire (marked A) into Terminal **2**.

Note: this is the default grounding method for factory-supplied 9387-FB-R enclosures.

IMPORTANT NOTE
<p>9387-FB-XX-R assemblies are factory-supplied with Option 1 grounding. If power is applied locally, for example during commissioning, when the trunk cable shield is NOT providing a ground connection, the spur cable shields must be grounded according to Option 2.</p> <p>When the trunk cable shield ground has been fully instated (or restored), the grounding method should be returned to Option 1.</p>

4.2.2.2 Trunk shield grounded at host; spur cable shields grounded at barrier

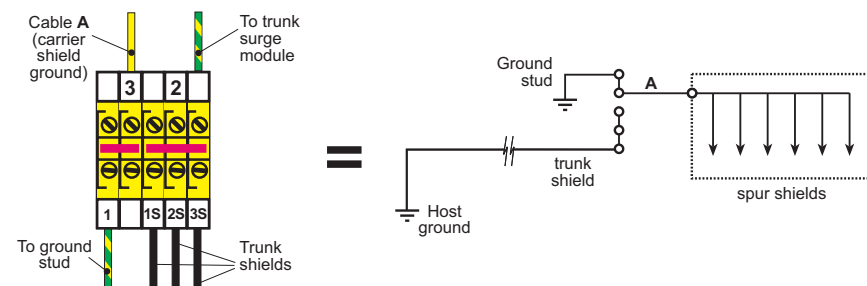

Figure 4.2 - Option 2

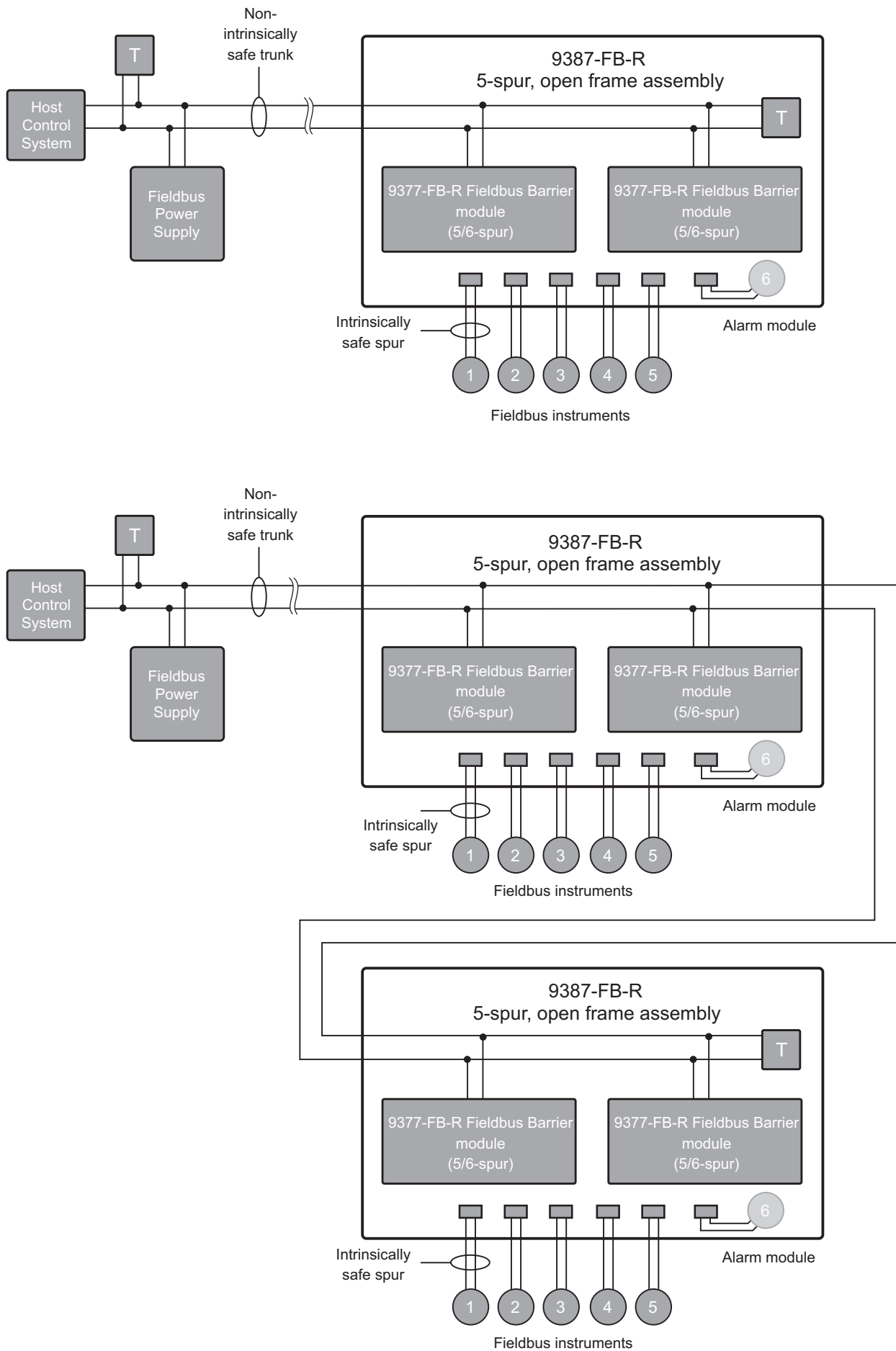

Figure 4.3 - Trunk Connection Options

With this arrangement, the fieldbus trunk shield is separated from the spur cable shields. It should be adopted if plant or local regulations require that the spur cable shields be grounded at the Fieldbus Barrier. For this arrangement, connect the carrier shield ground wire (marked A) into Terminal **3**.

Note: After configuring the required grounding option, tighten all screw terminals to a recommended torque of 0.6 Nm.

4.2.3 Permitted assembly combinations

The maximum number of redundant intrinsically safe spurs that can be supported on a trunk segment is 12. The permitted assembly combinations are shown in Figure 4.3.

Note that a fieldbus terminator (9378-FT) must be fitted (see Section 4.4) to the last/furthest assembly on the segment. See also Figure 4.6.

4.3 Trunk connections

Each Trunk Termination Assembly (TTA) is provided with two access holes and grommets for trunk wiring; one for the incoming trunk and another for onward linking to an additional assembly, if necessary.

	WARNING!
	<p>No part of the Trunk Terminal Assembly may be worked while the enclosure is powered, unless the environment is known to be non-hazardous.</p>

4.3.1 Trunk Terminal Assembly

The trunk cables are terminated in the Trunk Terminal Assembly (TTA). This is a sub-enclosure with a protective lid, secured with a single screw. This assembly, together with its warning label, is intended to deter a user from working on the trunk connections without isolating trunk power. See Figure 4.6.

Trunk cables enter the TTA through grommets and these must be cleanly cut with a sharp knife to ensure the IP30 rating is maintained (see Section 4.3.2). The grommet is supplied with the cone facing into the TTA, but the user is free to reverse this and allow the cone to extend outwards.

Terminals are provided to allow a variety of wiring arrangements, according to the particular requirements of the installation:

- "Trunk In" cable only
- "Trunk In" and "Trunk Out" cables
- Active and spare "Trunk In" cables
- Active and spare "Trunk In" cables with overall cable shield
- Active and spare "Trunk In" cables and "Trunk Out" cable

CAUTION
<p>The '+' and '-' wires of a 'spare' trunk in cable must be connected only to terminals marked 'NC'. This ensures that the spare cable is not electrically connected in parallel with the 'active' trunk in or trunk out cables. The cable shield of the spare cable should be connected to an 'S' terminal.</p> <p>All 'spare' trunk-in connections ('+', '-' and shield) must be firmly grounded at the host.</p>

4.3.2 Trunk cable wiring

Connect the trunk cable(s) in the following way.

- a) Loosen the captive screw of the transparent protective cover on the TTA. Slide out the cover and move it to one side to obtain access.

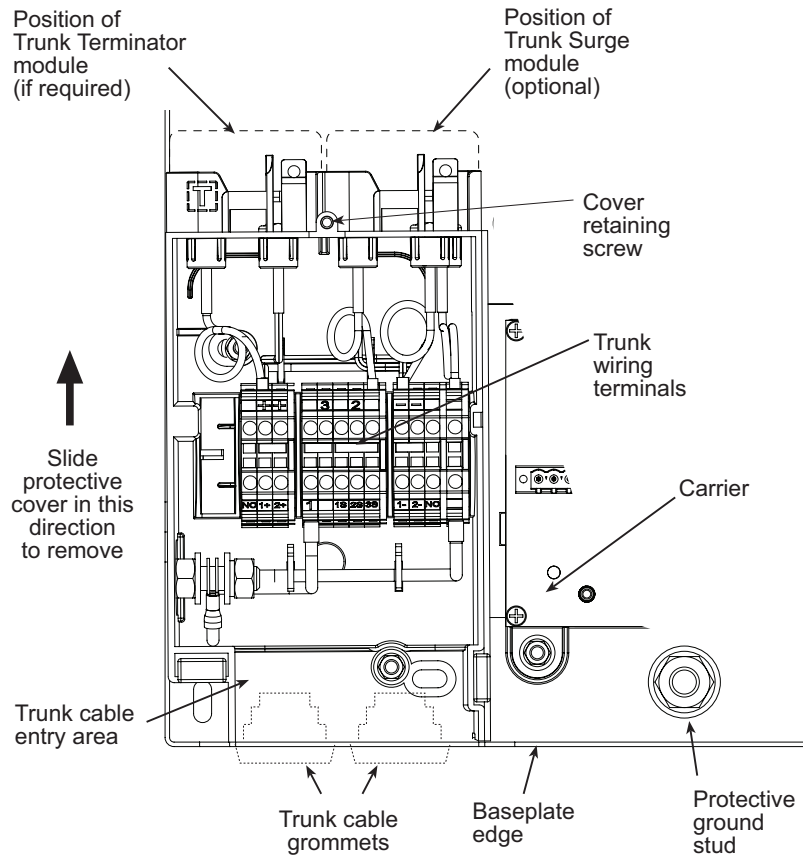

Figure 4.4 - Trunk Termination Assembly (TTA)

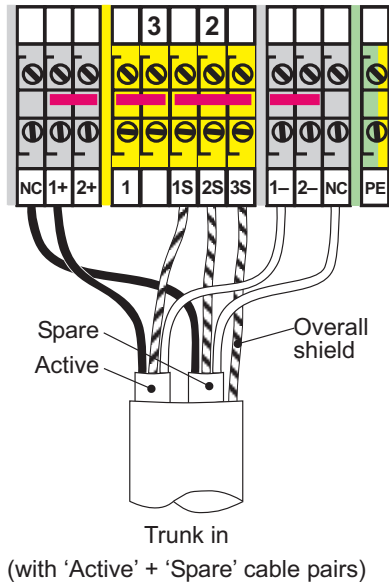

Figure 4.5 - 'Trunk In' with Active & Spare cable pairs

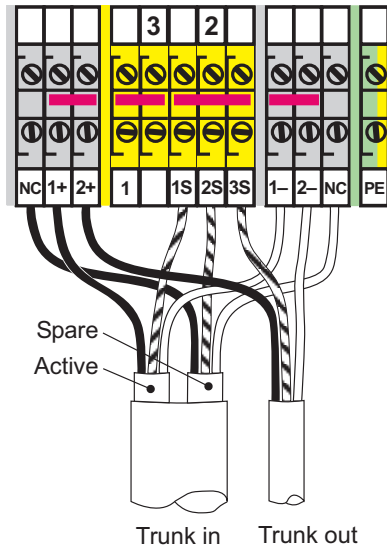

Figure 4.6 - Active & Spare 'Trunk In' cables plus 'Trunk Out' cable

- b) The trunk cable(s), which will be free of any armouring and presented as a shielded pair, should be fed through the supplied grommet, which should have been cut cleanly with a sharp knife to ensure that the IP30 rating for the TTA will be maintained.
- c) Cable ferrules must be fitted to any stranded cable or screen wiring that is being used
- d) Connect the prepared ends of the fieldbus trunk cable(s) into the appropriate '+', '-', and 'S' terminals, shown in Figure 4.7, and tighten the screw terminals to a recommended torque of 0.6 Nm.

Note: Figure 4.7 shows the screw-terminal '-PS' assembly option, but the '-PC' cage-clamp terminal arrangement is similar.

Check Section 4.2.2 to confirm that the chosen fieldbus-ground option is correctly wired, and adjust if necessary.

- e) Replace the transparent protective cover over the terminal block and secure it with the retaining screw to a recommended torque of 0.6 Nm.

4.4 Trunk Terminator module 9378-FT

If the assembly provides the last (or only) spur connections on the segment, the trunk must be terminated correctly to ensure that the optimum signal quality is maintained. The Trunk Termination Assembly (TTA) has provision for an 9378-FT Terminator module to be fitted when required.

NOTE
A terminator should be used only at the end points of the trunk wiring. Connecting a terminator at any other point on the trunk will degrade the signal. Refer to Figure 4.3 for additional information.

The 9378-FT is a two-pin module that plugs into the upper end face of the Trunk Terminator Assembly. See Section 5.3 for fitting and removal details.

4.5 Trunk Surge module 9376-SP

The 9376-SP Trunk Surge module can be fitted to the TTA to prevent damage to the equipment from voltage and current surges that could occur on the trunk wiring.

The 9376-SP is a four pin module that plugs into the upper end face of the Trunk Terminator Assembly. See Section 5.4 for fitting and removal details.

4.6 Spur connections

Refer to Figure 4.7 for additional details.

The spur cables can be connected directly onto the fieldbus barrier carrier or through a Spur Surge module (FS32). If Spur Surge modules are not used, sub-section 4.6.2 can be ignored.

4.6.1 Connecting the spur cables

The spur cables, which will be free of any armouring and presented as a shielded pair,

IMPORTANT

- If spur surge modules are fitted, it is recommended that a small (approx. 15mm) length of additional cable is allowed for. This will permit cable adjustments if a Spur Surge module is subsequently removed.
- Cable ferrules must be fitted to any stranded cable or screen wiring that is being used.

Connect the prepared ends of the fieldbus spur cables into the '+', 'S' and '-' terminals on the carrier (or surge module, if fitted), making sure that the same polarity is observed for all spurs.

4.6.2 Fitting FS32 spur surge-protection modules

FS32 modules are pluggable surge-protection units that integrate easily with the standard pluggable connector and which direct excessive spur surge currents to the protective local ground.

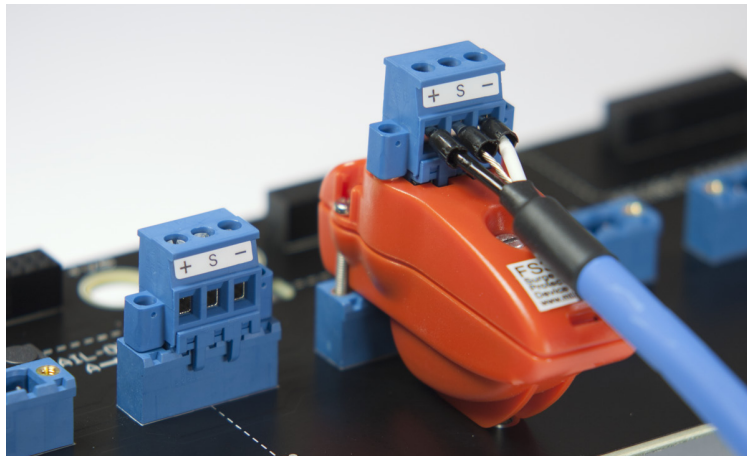

Figure 4.7 - FS32 spur surge-protection module fitted on spur connector

To fit an FS32:

1. Unscrew the two captive screws securing the standard pluggable connector (supplied on the carrier) and remove it from its socket.
2. Insert the FS32 module into the now vacant socket on the carrier, tighten the two side securing screws, and the central "protective ground" screw, to a recommended torque of 0.4 Nm.
3. Fit the connector (removed at Step 1 above) into the socket on the FS32 and tighten its two securing screws also to a recommended torque of 0.4 Nm.

Removal of a Spur Surge module is the reverse of the fitting process. See also Section 5.3.1 on page 15 for information on cable 'adjustment' if one of these modules is taken out of use.

4.7 Final checks

Check:

- that there are no loose cable ends that could cause an open or short circuit.
- that the protective trunk wiring cover is in place on the Trunk Terminal Assembly.
- that no tools (e.g. screwdrivers) or loose items are present.
- that if, and only if, the assembly *is the last one* on the fieldbus segment, that a 9378-FT Terminator module is fitted into the socket on the TTA.
- that the required grounding link is securely connected.

5 MAINTENANCE

When the enclosure is installed in a hazardous area it is important for personnel to understand what activities are permissible when fieldbus power is present and what are not.

	WARNING!
	Read and understand what work is permitted on the equipment. Failure to comply with these instructions can endanger the lives or health of personnel and risk damage to the plant and the environment.

5.1 General

The following assembly items may be installed, removed or disconnected while the trunk is powered.

- 9377-FB-R Fieldbus Barrier module(s) *
- 9378-FT Terminator module
- 9376-SP Trunk Surge module
- 9379-ALM Alarm module
- FS32 Spur Surge modules and any spur wiring

All other wiring in or to the assembly requires the trunk power to be isolated, or a gas clearance certificate to be obtained before any work is carried out.

* NOTE
The earlier, non-redundant 9377-FB barrier model cannot be fitted in place of the 9377-FB-R; it has built-in mechanical differences to prevent its substitution.

5.2 Fieldbus Barrier maintenance procedures

The 9387-FB Fieldbus Barrier is designed to tolerate the failure of one or more spur circuits in either Fieldbus Barrier module. However, a failed module should be replaced as quickly as possible to avoid any loss of power or communication to the spurs from subsequent failures. If a barrier module has one or more LED indicators showing solid red, meaning that the internal spur circuits have failed (see "Troubleshooting"), then it should be replaced.

5.2.1 Fitting and removal techniques

The individual 9377-FB-R Redundant Fieldbus Barrier module(s) may be fitted or removed without isolating the trunk power. The trunk connections to the barrier module on the carrier have spark suppression by design and cannot cause ignition while they are being connected or disconnected. This section should be read to understand the physical removal or installation of a barrier, but read section 5.2.2 on page 13 to understand the recommended procedure for replacing a barrier when powered.

5.2.1.1 Removing a Fieldbus Barrier module (refer to Figure 5.1)

- a) Loosen the three captive fixing screws (C & D) on the module to release it. The screws are all spring-loaded and should retract when the thread has disengaged.
- b) Slowly pull the 9377-FB-R Fieldbus Barrier module away from its connections on the carrier until the safety retaining clip (B) stops further removal.
- c) Press the clip (see bold black arrow) towards the module until the barrier is released and can be removed completely.

5.2.1.2 Fitting a Fieldbus Barrier module (refer to Figure 5.1)

Note: Before fitting a 9377-FB-R Fieldbus Barrier module check the connection pins on its underside to ensure that they have not been bent or damaged in any way. **Do not use**, or attempt to repair, a barrier module that has any of its pins *bent or damaged*, because this might affect its safety and will invalidate the certification.

- a) Engage the locating guides (A) of the 9377-FB-R Fieldbus Barrier module into the sockets provided on the carrier and push the module fully into place.
- b) Tighten the three captive fixing screws (C & D) to a recommended torque of 0.9Nm to secure it.

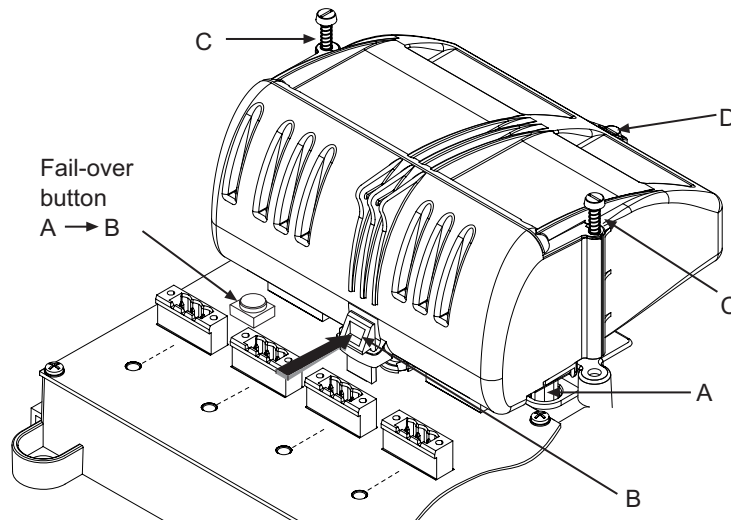

Figure 5.1 - Fieldbus Barrier module - fitting & removal

5.2.2 Use of Fail-over button when replacing a barrier

Although direct removal of the “active” barrier of a redundant pair will cause all spurs to be redirected automatically to the “standby” barrier, the following technique is recommended for the replacement of a barrier.

Two fail-over buttons are provided on the module carrier to permit a manual transfer of spur control from one barrier module to another - $A > B$ or $B > A$. These are used during module replacement to ensure that all spurs remain powered. The following four-step example illustrates a typical “hot-swap” procedure.

Situation 1

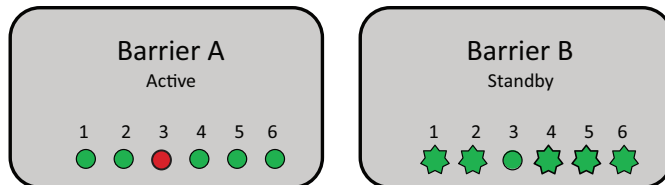

- = Active, healthy
- = Failed
- ★ = Standby, healthy
- ★ = Standby, Failed

1. Spur 3 on Barrier A has failed and shows red. Control of this spur has transferred automatically to Spur 3 of Barrier B, which now shows a solid, not flashing, green. Barrier A should therefore be replaced to ensure continued redundant service.

Situation 2



2. Pressing the $A > B$ fail-over button beside Barrier A, passes all spur control to Barrier B. All spur LEDs on Barrier A now flash, while those on Barrier B are solid green; this indicates that Barrier A is now in “standby” and Barrier B is “active”.
3. Barrier A can now be removed from the carrier (following the procedure in Section 5.2.1.1 on page 12) and replaced with a known good module. On replacement, Barrier A remains in “standby”.

- To restore Barrier A to the "active" mode, press the B>A fail-over button located beside Barrier B. Control of all spurs now returns to Barrier A while Barrier B goes into "standby" mode.

*** NOTE**

Operating the fail-over buttons will not allow active spurs to be transferred to a missing or failed barrier module.

Terminator and Trunk Surge Protection modules

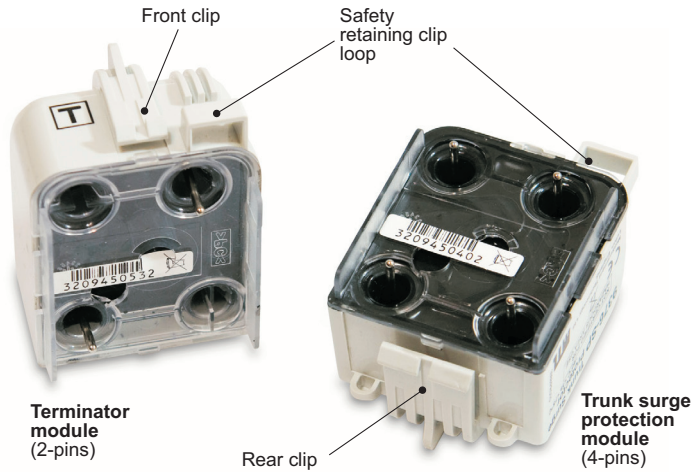

Figure 5.3 - Module connectors and retaining clips

5.2.3 Fitting and removal

Both modules have connectors that are designed to prevent an ignition-capable spark when the module is installed or removed. The modules are not interchangeable but the method of installing and removal is the same.

Do not use, or attempt to repair, a module that has any of the pins on its underside *bent or damaged*, because this might affect its safety and will invalidate the certification.

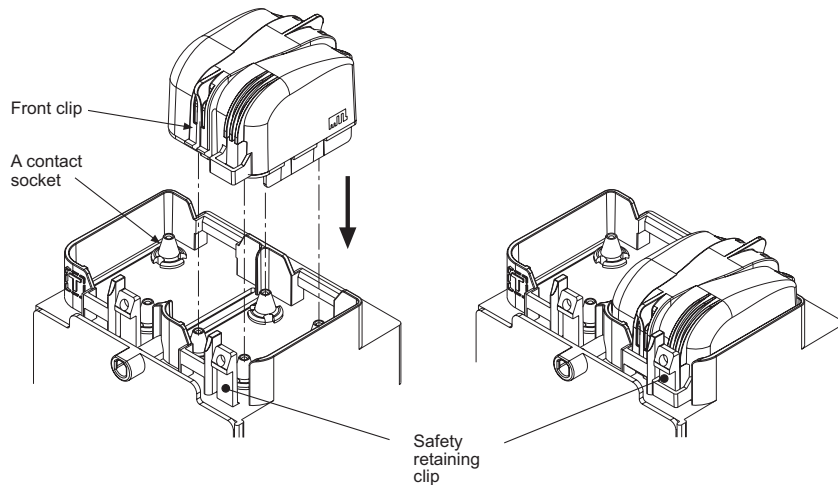

Figure 5.4 - Mounting a module - e.g. Trunk Surge Protection module

5.2.3.1 Mounting a module

Refer to Figure 5.4.

Orientate the module so that the smaller front clip is facing the user, then:

- lower the module so that the safety retaining clip on the TTA housing fits into the loop on the module
- locate the terminal pins into their contact sockets on the TTA housing and
- push the module home until front and rear retaining clips engage.

5.2.3.2 Removing a module

Refer to Figures 5.3 and 5.4 for further information.

Removal is a two-step process that first breaks the electrical connection, followed by the physical removal of the module from the TTA.

- Press the clip at the rear of the module and tilt the module forward until the clip disengages at the rear.
- Press the front clip and withdraw the module from its socket until it is stopped by the safety retaining clip, then press down on the safety retaining clip enough to release it and pull the module away from the TTA body without rotating or twisting it.

5.3 Spur connections

All of the spur connections are intrinsically safe and therefore may be live-worked in a hazardous area without 'gas clearance', while complying with normal 'permit to work' procedures. If spur wiring is removed from a connecting plug, ensure that the same polarity is observed when it is reconnected.

For additional information refer to Section 4.6 on page 11.

5.3.1 Removing a Spur Surge module & spur cable adjustment

If an FS32 Spur Surge module needs to be removed from circuit, use the following procedure.

- a) Loosen the two screws securing the pluggable, spur-wiring connector to the Spur Surge module and unplug it.
- b) Loosen all three of the Spur Surge module's fixing screws and unplug it from the carrier.
- c) Plug the spur connecting plug into its mating socket on the barrier carrier and tighten the fixing screws to a recommended torque value of 0.4 Nm.

5.3.2 Adding a Spur Surge module & spur cable adjustment

If an FS32 Spur Surge module is added, follow this simple procedure. Refer also to Section 4.6.1 for further fitting details.

- a) Loosen the two screws securing the pluggable, spur-wiring connector to the carrier and unplug it.
- b) Plug the Spur Surge module into the vacant socket on the carrier and tighten the two fixing screws and its grounding screw, all to a recommended torque of 0.4 Nm.
- c) Plug the spur connecting plug into its mating socket on the Spur Surge module and tighten the fixing screws to a recommended torque of 0.4 Nm.

5.4 Trunk connections

	WARNING!
	No part of the Trunk Terminal Assembly may be worked while the assembly is powered, unless the environment is known to be non-hazardous.

Before any work starts on the Trunk Terminal Assembly the trunk power to the enclosure must be isolated, or a gas clearance certificate obtained.

Once the conditions are known to be safe, the protective plastic cover of the Trunk Terminal Assembly (TTA) may be removed. Unscrew its securing screw, slide it out until it becomes free and then move it to the side to obtain access.

Refer to Section 4.3 and 4.2 for additional information about trunk wiring connections.

When any changes or checks have been carried out, ensure there are no loose implements left inside the TTA before replacing its protective cover. Slide the cover into its locations and tighten the securing screw to a recommended torque of 0.6 Nm.

5.5 Regular Maintenance checks

Check the general condition of the installation occasionally to ensure that no deterioration has occurred. At least every two years (and more frequently for harsh, dusty or dirty environments) check:

- the condition of all wire connections/terminations/screens.
- that all of the fixing screws are secure.
- that there are no signs of damage or corrosion.

In addition, take advantage of plant maintenance shutdown periods or **whenever the area is known to be non-hazardous**, to check wiring quality by confirming that the dc voltage on the fieldbus trunk, when measured at the assembly, is >16V. This can be performed using a multimeter or an FBT-6 fieldbus tester.

5.5.1 Proof testing of redundancy mechanism

The Fieldbus Barrier is designed to automatically transfer spurs between the 'active' to the 'standby' barrier modules in the event of internal electronic failures. This mechanism may be proof-tested by manually forcing the transfer of all spurs between the modules using the Fail-over buttons located on the module carrier (see clause 5.2.2 and diagram 5.1). Pressing the A > B button will force all spurs to transfer from module A to module B. Pressing the B > A button will return the spurs to module A.

Operating the Fail-over buttons will reliably transfer all spurs without interrupting the fieldbus communication; however, repeated operation is not advised if the Fieldbus Barrier is operating in a live fieldbus segment. Use of the Fail-over buttons is therefore recommended only for periodic proof-testing during plant shutdowns, and for the purpose of module replacement.

NOTE
Operation of the Fail-over buttons will <i>not</i> cause active spurs to be transferred to a missing or failed barrier module.

6 TROUBLESHOOTING

The Redundant Fieldbus Barriers are fitted with LED indicators to assist the user in fault identification.

Consult the following tables to understand the meaning of the LED states.

Power LED (Green)

ON	OFF
Trunk power applied	Insufficient or no trunk power

NOTE

The **Power LED** will not light until the voltage at the barrier has risen to a value of at least 15.7V, but could remain lit even after the voltage has dropped to around 13.0V. DO NOT assume the Power LED indicates a voltage of 16V or more.





If the green Power LED is not lit, check:

- the polarity and integrity of the trunk cable connections to the enclosure.
- that the d.c. supply powering the incoming trunk is operating correctly.

Spur LEDs

The following tables show the possible modes of operation of the spur LEDs on the barriers and their associated meanings.

Active spur LED indication

Colour	State	Appearance	Description
Green	Steady		Channel powering spur, spur OK
Green	Flashing ^{Note 1}		Channel powering spur but spur open circuit
Red	Steady		Internal fault
Yellow	Steady ^{Note 2}		Short to shield on one or more spurs
Yellow	Flashing ^{Note 1}		Spur short circuit, or spur in current limit state

Notes:

1. Flashing occurs at a rate of approximately 2 pulses per second.
2. Affects **all spurs** on that barrier that previously showed a steady green.

Standby spur LED indication

Colour	State	Appearance	Description
Green	Pulsed		Spur OK
Red	Pulsed		Internal fault

CAUTION

MTL Fieldbus Barrier are designed to operate reliably in industrial environments and comply with international standards for immunity to electromagnetic radiation. However, damage may occur if the apparatus is exposed to extreme levels of radiated electrical noise, for example from “walkie-talkie” radios, or electric arc-welding. If local welding activity is unavoidable, power should first be removed from the Fieldbus Barrier.

7 ALARM MODULE - OPERATION & CONFIGURATION

7.1 Introduction

As with all redundant systems, early notification of the failure of a system component is important so that the fault can be rectified before a second fault is allowed to occur. A second fault is likely to interrupt the process, so restoring redundant operation is vital in maintaining high levels of system availability. With MTL's Fieldbus Barrier, notification of the health of the redundant barrier modules can be made available to the host control system via the fieldbus network.

Host notification is achieved using an Alarm Module mounted on the Fieldbus Barrier carrier. The alarm module is a Foundation Fieldbus Device that is connected to the fieldbus segment using one of the six available spurs, and appears on the segment 'live list' along with other devices that are supported on the segment. The device monitors both barrier modules and signals the healthy/failed status of each spur via fieldbus Digital Input (DI) function blocks. Each barrier module is assigned its own DI function block; the control system must therefore monitor the status of both DIs in order to detect a spur or a module failure.

The integrated fieldbus device is also able to provide additional diagnostic information that is not normally available in conventional fieldbus barrier installations. Importantly, each of the Fieldbus Barrier modules is able to detect a short-circuit or a low impedance between the plus (+) or minus (-) connections of any spur and the shield (S) of the spur cable. Undetected "short to shield" faults jeopardise the reliability of a fieldbus network, because a second fault may cause the loss of one or more active spurs.

With MTL's Redundant Fieldbus Barrier, as well as being indicated by the module's status LEDs, a "short-to-shield" fault is also indicated via status bits contained in the fieldbus alarm module's Analog Input (AI) function blocks. This can therefore give early indication of faults via the fieldbus control system, allowing early rectification.

Note: The fieldbus alarm module also incorporates a temperature sensor, which can, if required, be used to ensure that the ambient temperature around the Fieldbus Barriers does not exceed the 75°C value required to promote reliable operation and compliance with certification requirements.

7.2 Device details

The fieldbus alarm device is an ABB type TTH300.

When supplied as part of a 9387-FB-R Redundant Fieldbus Barrier assembly, or separately as an 9379-ALM alarm module, the device's alarm thresholds are pre-configured to correspond to the output signals of the MTL Fieldbus Barrier modules. Further device configuration should not be necessary.

It contains the following FF blocks:

Qty	Block
1	Resource block
4	AI (analogue input) block
1	ePID block (PID controller with expanded features)
2	DI (digital input) block
1	AO (analogue output) block
1	Temperature transducer block
1	Extended diagnostics transducer block
1	HMI transducer block (LCD)

As mentioned earlier, the key block types of interest in this application are the DI and the AI and these are covered in turn below.

7.2.1 DI Function Blocks: failure alarm status of 9377-FB-R barrier modules

The two discrete input blocks conform to FF standard FF891 and are used by the TTH300 for cyclic reading out of extended diagnostics information.

For the MTL redundant Fieldbus Barrier, the output of the blocks indicate the health of the 9377-FB-R barrier modules as follows:

Digital Input (DI) Block 1:

Output false (0): 9377-FB-R Barrier Module A healthy

Output true (1): 9377-FB-R Barrier module A failed

Digital Input (DI) Block 2:

Output false (0): 9377-FB-R Barrier Module B healthy

Output true (1): 9377-FB-R Barrier module B failed

7.2.2 Analog Input (AI) Function Blocks: spur short-to shield detection

There are four AI blocks, of which block 2 and 3 are the Primary Values. Block 1 can contain a value derived from the values contained in block 1 and 2, and block 4 is assigned to a Secondary Value.

In use, block 2 and 3 include pre-configured Discrete Output values that indicate the presence of a spur short-to-shield fault, as follows:

Analog Input (AI) Block 2:

Output false (0): Spurs OK

Output true (1): Short to shield on one or more spurs

Analog Input (AI) Block 3:

Output false (0): Spurs OK

Output true (1): Short to shield on one or more spurs

7.3 Alarm module fitting or replacement

A standard 9387-FB-Px-R assembly is supplied with the Alarm module fitted to Spur 6.

The alarm module, if supplied as a *separate* item, is ready wired with two connectors, a (2-wire) blue connector for the fieldbus 'Spur' connection and a black (3-wire) connector for the 'Alarm' signals from the barriers.

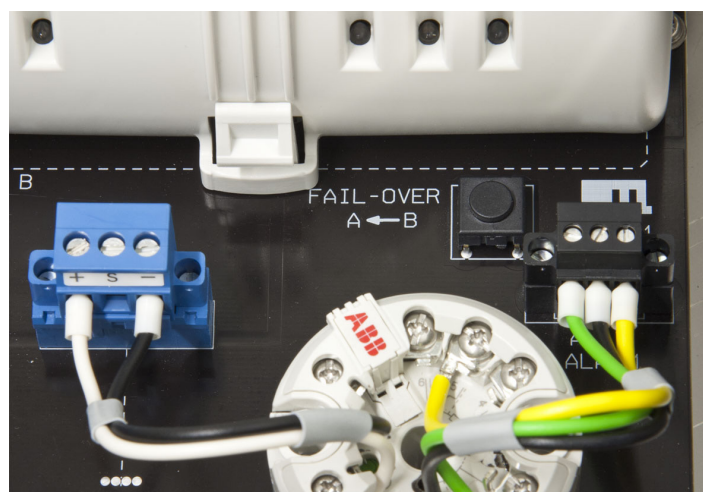

Figure 7.1 - Alarm module wiring connections

NOTE

It is permitted for the alarm module to be removed or installed while the enclosure is powered because all its connections are rated "intrinsically safe".

7.3.1 To remove the alarm module:

1. Loosen the two captive securing screws on the blue (spur) connector and extract the connector - repeat for the black (alarm) connector.
2. Loosen the two captive securing screws on the alarm module and lift it away from the circuit board complete with its wiring and connectors.

7.3.2 To install an alarm module:

The carrier circuit board is designed to provide a mounting for the alarm module beside the Spur 6 connection. Two threaded bosses are provided in the carrier circuit board to mount the module.

CAUTION

Do not exceed 0.4Nm when tightening the following securing screws.

1. Locate the alarm module over the threaded connections on the carrier circuit board and use the captive securing screws to attach the module to the carrier.
2. Insert the blue (2-wire) connector into the Spur 6 socket on the carrier (removing any existing connector first) and tighten the two securing screws.
3. Insert the black connector into the Alarm socket on the carrier (removing any existing connector first) and tighten the two securing screws.

8 ATEX INFORMATION

The Essential Health and Safety Requirements (Annex II) of the EU Directive 94/9/EC [the ATEX Directive - safety of apparatus] requires that the installation manual of all equipment used in hazardous areas shall contain certain information. This annex is included to ensure that this requirement is met. It complements the information presented in this document and does not conflict with that information. It is only relevant to those locations where the ATEX directives are applicable.

8.1 General

- a) In common with all other electrical equipment installed in hazardous areas, this assembly must only be installed, operated and maintained by competent personnel. Such personnel shall have undergone training, which included instruction on the various types of protection and installation practices, the relevant rules and regulations, and on the general principles of area classification. Appropriate refresher training shall be given on a regular basis. [See clause 4.2 of EN 60079-17].
- b) An assembly can comprise:
 - Trunk Terminal Assembly and Carrier on a baseplate
 - 9377-FB-R Fieldbus Barrier (x2)
 - 9379-ALM Alarm module (optional)
 - 9378-FT Fieldbus Terminator (optional)
 - 9376-SP Trunk Surge module (optional)
 - FS32 Spur Surge modules (optional)
- c) Assemblies have been designed and manufactured so as to provide protection against all the relevant additional hazards referred to in Annex II of the Directive, such as those in clause 1.2.7.
- d) Assemblies have been designed to meet the requirements of electrical apparatus in accordance with EN 60079-0, EN 60079-1, EN 60079-7, EN 60079-11, EN 60079-18 and EN 60079-27.

8.2 Installation

- a) The installation should comply with the appropriate European, national and local regulations, which may include reference to the IEC code of practice IEC 60079-14. In addition particular industries or end users may have specific requirements relating to the safety of their installations and these requirements should also be met. For the majority of installations the Directive 1999/92/EC [the ATEX Directive - safety of installations] is also applicable.
- b) Assemblies must not be subjected to mechanical and thermal stresses in excess of those permitted in the certification documentation, this manual and the product specification.
- c) All cables must be chosen to withstand the temperatures at which an assembly is designed to operate. See product specification for details.
- d) An assembly must not be installed in a position where it may be attacked by aggressive substances.

Read also the *Schedule of limitations* (here) for additional or more specific information.

Schedule of limitations

1. The component shall only be powered from supplies conforming to IEC 61158
2. When a Trunk Surge Module is fitted, the power input circuit will not withstand a 500V a.c. isolation test to earth. This must be taken into account during installation.
3. When one or more Spur Surge Modules are fitted, the spur outputs will not withstand a 500V a.c. isolation test to earth. This must be taken into account during installation.
4. The component must be mounted in an appropriately certified enclosure when used in hazardous areas. When used in safe areas, the enclosure must provide ingress protection of at least IP20.
5. The component is intended to meet the requirements for temperature class T4 when used within its certified temperature range.

8.3 Inspection and maintenance

- a) Inspection and maintenance should be carried out in accordance with European, national and local regulations which may refer to the IEC standard IEC 60079-17. In addition specific industries or end users may have specific requirements which should also be met.
- b) Care should be taken to limit dust accumulation on the exterior of the apparatus to a depth not exceeding 5mm.
- c) Maintenance of internal components while powered is limited to those actions permitted in Section 5 of this manual.

8.4 Repair

The modules used in this product cannot be repaired by the user and must be replaced with an equivalent certified product.

8.5 Marking

Each certified component is marked in compliance with the Directive and CE marked with the Notified Body Identification Number.

This information applies to products manufactured during or after the year 2012.

Assembly label

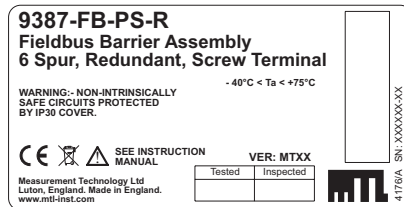

Barrier markings

9377-FB-R Fieldbus Barrier Module, 6-Spur
 -40°C < Ta < 75°C
 II 2 (1) G
 Ex de ib mb [ja Ga] IIC Gb
 FISCO Power Supply (Spurs)
 Part of Certificates
 IECEX BAS09.0081U
 Baseefa 09ATEX0184U

CE 1180
 Measurement Technology Ltd.
 Luton, England. Made in England.



Terminator marking

9378-FT Fieldbus Terminator
 -40°C < Ta < 75°C
 RATED VOLTAGE 32V
 Baseefa 09ATEX0323U
 II 2G Ex de mb IIC T4 Gb
 IECEX BAS09.0087U
 CE 1180
 Measurement Technology Ltd.
 Luton, England. Made in India.



Ex d e mb IIC T4 Gb
 -40°C < Ta < +75°C
 NCC 6651/10U

4088/A

Trunk surge protector marking

9376-SP Trunk Surge Protector
 -40°C < Ta < 75°C

Baseefa 09ATEX0324U
 II 2G Ex de mb IIC T4 Gb
 IECEX BAS10.0005U

CE 1180
 Measurement Technology Ltd.
 Luton, England. Made in India.



9 APPENDIX 1 - ENCLOSURE WIRING DIAGRAM

Schematic wiring diagram for 9387-FB-Px-R

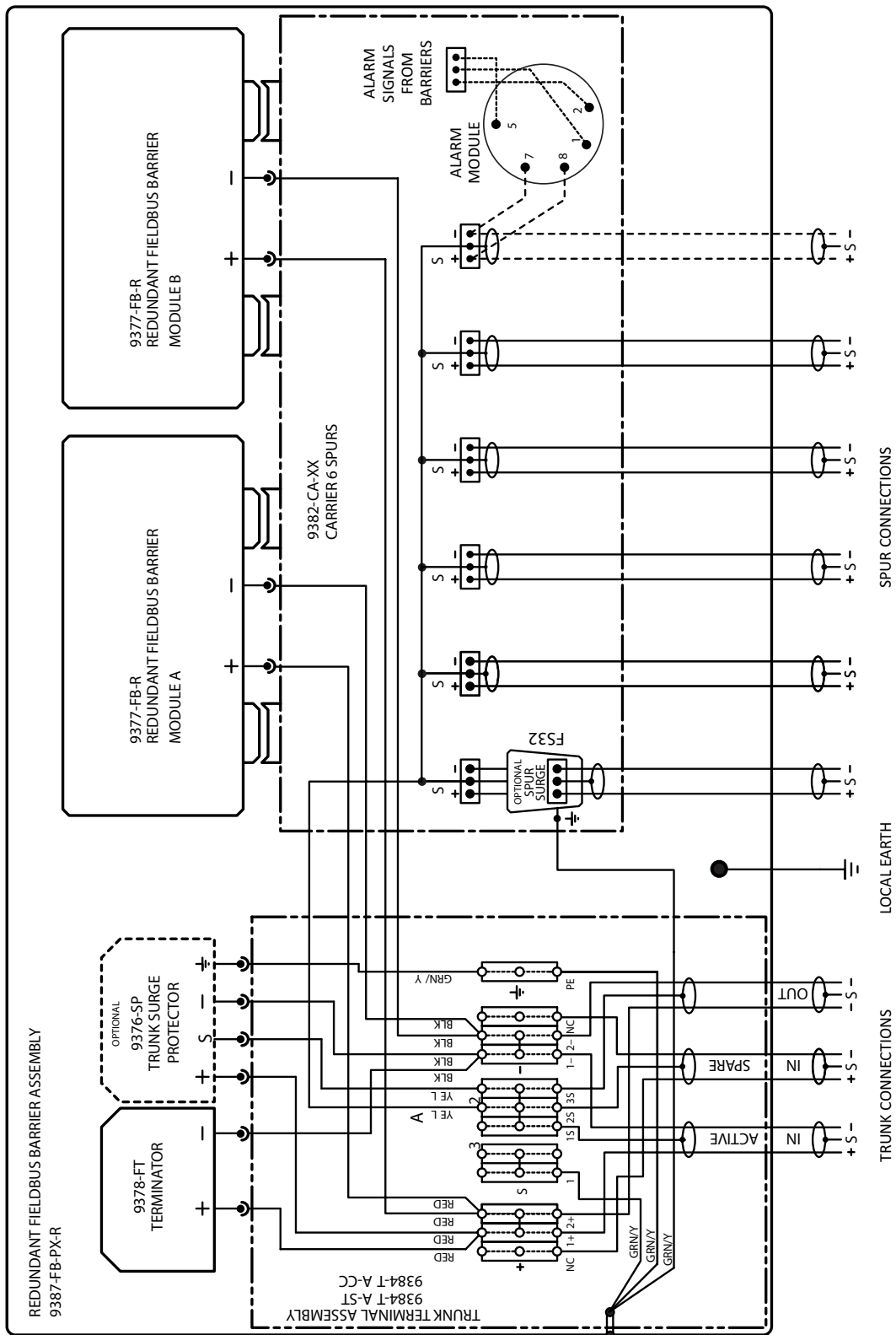

NOTE: CABLE 'A' IS SHOWN IN FACTORY DEFAULT GROUNDING OPTION - I.E. SINGLE POINT GROUNDING AT HOST

This page left blank intentionally

This page left blank intentionally

MTL Instruments Pty Limited

205-209 Woodpark Road
Smithfield, New South Wales 2164
Australia

Tel: + 61 1300 308 374 Fax: + 61 1300 308 463
E-mail: mtlsales@cooperindustries.com

Cooper Electric (Shanghai) Co. Ltd.

Room 2001, China Life Tower
16 Chao Yang Men Wai Street
Chao Yang District, Beijing
China 100020

Tel: + 86 10 5980 0231 Fax: + 86 10 8562 5725
E-mail: mtl-cn@cooperindustries.com

MTL Instruments sarl

Les Carrés du Parc
10 rue des Rosiéristes
69410 Champagne au Mont d'Or
France

Tel: +33 (0)4 37 46 16 53 Fax: +33 (0)4 36 46 17 20
E-mail: info@mtl-inst.fr

MTL Instruments GmbH

An der Gumpgesbrücke 17
D-41564 Kaarst
Germany

Tel: +49 (0)2131 718930 Fax: +49 (0)2131 7189333
E-mail: info@mtl.de

MTL India

No. 36, Nehru Street
Off Old Mahabalipuram Road
Sholinganallur
Chennai - 600 119
India

Tel: + 91 (0)44 24501660/24501857 Fax: + 91 (0)44 24501463
E-mail: sales@mtlindia.com

MTL Italia srl

Via Cantù 11
I - 20092 Cinisello Balsamo MI
Italy

Tel: +39 (0)2 61802011 Fax: +39 (0)2 61294560
E-mail: info@mtl-inst.it

Cooper Crouse-Hinds Japan KK

MT Building 3F
2-7-5 Shiba Daimon, Minato-ku Tokyo
Japan 105-0012

Tel: +81 (0)3 6430 3128 Fax: +81 (0)3 6430 3129
E-mail: info@cooperindustries.jp

Cooper Crouse-Hinds Korea

12F, Vision Tower
707-2 Yeoksam-dong, Gangnam-gu
Seoul 135-080, South Korea

Tel: +82 2 538 3481 Fax: +82 2 538 3505
E-mail: MTL-Korea@cooperindustries.com

MTL Instruments BV

MTL Instruments BV
Terheijdenseweg 465, 4825BK Breda
The Netherlands

Tel: +31(0)76 7505360 Fax: +31(0)76 7505370
E-mail: mtl.benelux@cooperindustries.com

Cooper Crouse-Hinds Pte Ltd.

No.2 Serangoon North Avenue 5
#06-01 Fu Yu Building
Singapore 554911

Tel: +65 6 645 9888 Fax: +65 6 487 7997
E-mail: sales.mtlsg@cooperindustries.com

MTL Instruments

Villa No. 4, Sector 2-17,
Street 6, PO Box 53234,
Abu Dhabi, UAE

Tel: +971 2 446 6840 Fax: +971 2 446 6841
E-mail: mtlgulf@mtl-inst.com

Measurement Technology Limited

Great Marlings, Butterfield, Luton, Beds
England LU2 8DL

Tel: +44 (0)1582 723633 Fax: +44 (0)1582 422283
E-mail: enquiry@mtl-inst.com

Cooper Crouse-Hinds MTL Inc

3413 N. Sam Houston Parkway W.
Suite 210, Houston TX 77086
USA

Tel: +1 281 571 8065 Fax: +1 281 571 8069
E-mail: csinfo@mtl-inst.com

