



Partek

PFA Fittings

*Catalog 4181/USA
December 2005*



Table of Contents

Parflare Series PFA Tube Fittings	
Product Overview	3
Flaring and Assembly Procedure	4
Straight Connectors	5-11
Elbow Connectors	11-14
Tee Connectors	15-19
Rediflare Tubing Unions	20
Tubing Plugs	20
Fitting Caps	20
Fitting Nuts	20
Pargrip Series PFA Tube Fittings	
Product Overview	21
Assembly Procedure	22
Straight Connectors	22-24
Elbow Connectors	24-26
Tee Connectors	26-27
Tubing Plugs	28
Fitting Caps	28
Fitting Nuts	28
Ferrules & Grippers	28
Parbond Series PFA Fusible Pipe Fittings	
Product Overview	29
Weld Examples	30
Straight Adaptors	30-32
Flange Adaptors	32
Bond Reducers	33
Union Adaptors	33
Bond Caps	33
PVDF Transition Adaptors	34
Elbow Connectors	34-35
Tee Connectors	35-36
Pipe Series PFA Schedule 40 Pipe Fittings	
Product Overview	37
Pipe Plugs	38
Pipe Nipples	38
Pipe Bushings	38
Pipe Couplings	39
Pipe Female Reducers	39
Pipe Elbows	39
Pipe Tees	39
Tools and Accessories	
NW Nut Wrench	40
MFT Manual Flaring Tool	41
FG Electronic Flare Gun	42-43
Offer of Sale	46

 **WARNING**

FAILURE OR IMPROPER SELECTION OR IMPROPER USE OF THE PRODUCTS AND/OR SYSTEMS DESCRIBED HEREIN OR RELATED ITEMS CAN CAUSE DEATH, PERSONAL INJURY AND PROPERTY DAMAGE.

This document and other information from Parker Hannifin Corporation, its subsidiaries and authorized distributors provide product and/or system options for further investigation by users having technical expertise. It is important that you analyze all aspects of your application and review the information concerning the product or system in the current product catalog. Due to the variety of operating conditions and applications for these products or systems, the user, through its own analysis and testing, is solely responsible for making the final selection of the products and systems and assuring that all performance, safety and warning requirements of the application are met.

The products described herein, including without limitation, product features, specifications, designs, availability and pricing, are subject to change by Parker Hannifin Corporation and its subsidiaries at any time without notice.

© Copyright 2003, Parker Hannifin Corporation, All Rights Reserved



Parker Hannifin Corporation
Partek Operation
Tucson, AZ

Parflare PFA Tube Fittings

Product Overview

The Parflare Fittings are ideally suited for any ultra-pure or corrosive chemical application. The fitting design yields a leak tight connection with minimal dead volume and can be used in side loading and vibrational applications. The connection is achieved by a heated flaring process utilizing an external heat source (HG Heat Gun) and PTFE mandrel (MFT Manual Flaring Tool), or by using Partek's optional FG Series Electronic Flare Gun. Parflare PFA fittings are supplied with PVDF nuts as standard. For PFA nuts add -T suffix to model number. High temperature (HT) nut/gripper assemblies for sizes 1/4" through 1" are sold separately. Please consult factory for other available configurations, materials, and custom assemblies.

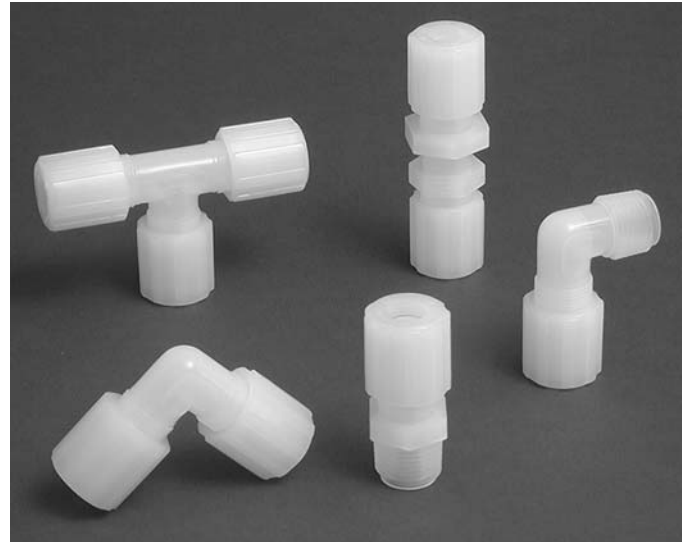

Features

PFA body manufactured from virgin High Purity PFA materials.

Ease of assembly.

Leak tight seal.

Numerous configurations including Redi-flare end connections.

Benefits

Less surface particulates, TOC, and anions resulting in cleaner operation.

Reduced assembly time, and costs.

Less downtime.

Reduced system complexity and cost.

Specifications

Materials of Construction:

Wetted Surfaces: PFA
External Surfaces: PVDF, PFA, Titanate

Pressure Ranges:

See Pressure/Temperature Chart below.

Temperature Ranges:

PVDF Nuts: Up to 212°F (100°C) and follow Pressure vs. Temperature Chart.

PFA Nuts: Up to 266°F (130°C) and follow Pressure vs. Temperature Chart.

HT Nuts: > 266°F (130°C) and follow Pressure vs. Temperature Chart.

Fitting Size	Tube Size
4	1/4" O.D. X 5/32" I.D.
6	3/8" O.D. X 1/4" I.D.
8	1/2" O.D. X 3/8" I.D.
12	3/4" O.D. X 5/8" I.D.
16	1" O.D. X 7/8" I.D.
20	1-1/4" O.D. X 1.10" I.D.

**PARFLARE FITTINGS WITH PVDF AND PFA NUTS
PRESSURE VS. TEMPERATURE**

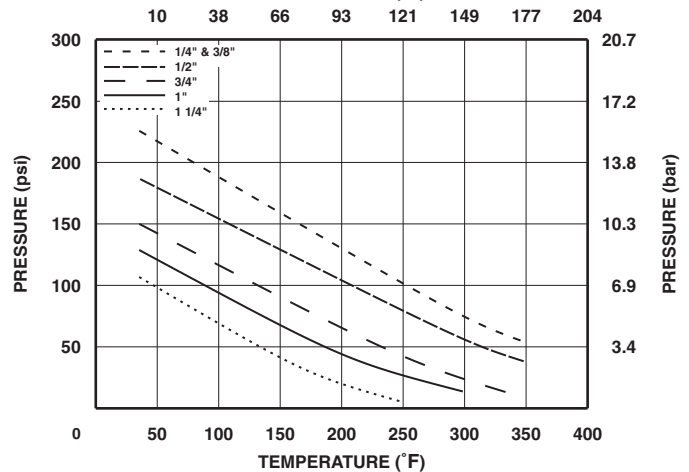

**PARFLARE FITTINGS WITH HT NUT ASSEMBLIES
PRESSURE VS. TEMPERATURE**

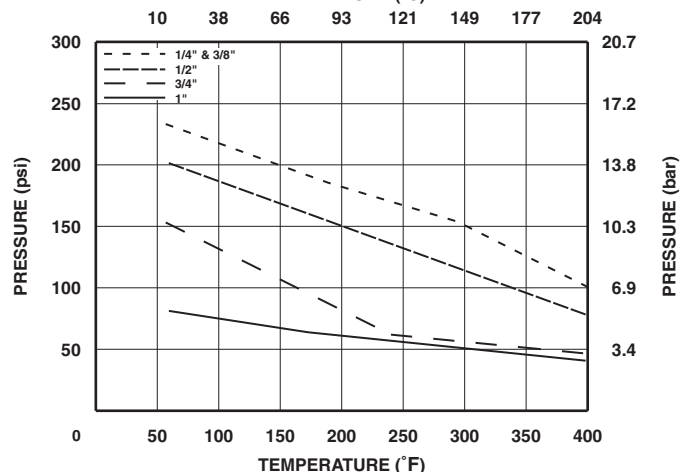

Parflare PFA Tube Fittings

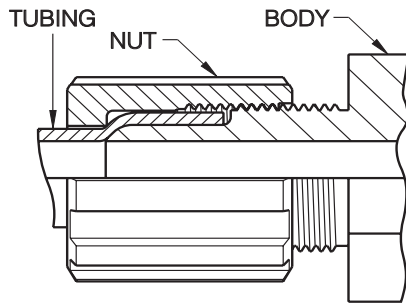

Parflare

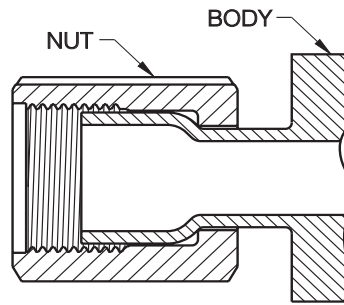

Redi-flare

MFT Manual Flaring Tool 1/4" - 1 1/4" Tubing Sizes*

1. Cut tubing evenly using a tube cutter:
TCTR-1 for 1/8" - 1/2"
TCTR-2 for 1/8" - 3/4"
TCTR-3 for 1/8" - 1 1/2"
2. For PVDF or PFA nuts slip small end over tubing. For HT nut assemblies slip small end of nut & small end of gripper over tubing.
3. Using the HG-1** Heat Gun on high setting, hold the end of tubing approximately 1/2" from gun and rotate tubing slowly until a fine whitish line appears around tube. Alternately, tubing can be heated for a timed period corresponding to [Table 1](#).
4. Remove tubing from heat source and immediately push over the appropriate flaring mandrel until end of tubing reaches the mandrel stop shoulder.
5. Maintain tubing on mandrel together until cool. [Refer to Table 1](#) for appropriate cooling times.
6. Allow tubing to cool on mandrel for an additional 2 to 3 minutes. Alternately the tubing can be assembled as per step 7 below immediately completing step 5 above.
7. Push flared tubing end over desired fitting body until it stops. Make sure that gap between end of tubing and fitting body shoulder is not more than .125" (3.2mm).
8. For PVDF or PFA nuts tighten onto fitting body as per [Table 1](#). For HT nut assemblies tighten onto fitting body [per Table 1](#). Once desired temperature has been reached, re-tighten [per Table 1](#).

* HT nut assemblies are for 1/4" - 1" sizes only.

** See page 41 for HG-1 Specifications.

FG Electronic Flare Gun 1/4" - 1" Tubing Sizes

1. Cut tubing evenly using a tube cutter:
TCTR-1 for 1/8" - 1/2"
TCTR-2 for 1/8" - 3/4"
TCTR-3 for 1/8" - 1 1/2"
2. For PVDF or PFA nuts slip small end over tubing. For HT nut assemblies slip small end of nut and small end of gripper over tubing.
3. Holding the flare gun, push lever to the most forward position.
4. Squeeze trigger 12 to 14 times to reset the mandrel to the start position.
5. Move top lever to the most rear position.
6. Insert the correct sized tubing. [See page 42](#).
7. Click trigger until resistance is lost.
8. Plug in tool and put the lever in the center position.
9. After 30 seconds you will hear a beep.
10. Ratchet the trigger until resistance is felt and note the amber LED coming on to indicate that cooling has begun.
11. After this light goes out, move the lever into the most forward position.
12. Remove the flared tubing.
13. Push flared tubing end over desired fitting body until it stops. Make sure that gap between end of tubing and fitting body shoulder is not more than .125" (3.2mm).
14. For PVDF or PFA nuts tighten onto fitting body as per [Table 1 below](#). For HT nut assemblies tighten onto fitting body [per Table 1](#). Once desired temperature has been reached, re-tighten [per Table 1](#).

Table 1

Fitting Size	1/4"	3/8"	1/2"	3/4"	1"	1 1/4"
Heating time (sec.) for PFA Tubing	15	25	25	25	25	25
Holding time on mandrel	20	20	20	20	25	25
Additional cooling time (min.)	2	2	3	3	3	3
PVDF & PFA Nuts minimum tightening torque (inch lbs./Nm)	5 / .6	8 / .9	11 / 1.2	14 / 1.6	30 / 3.4	75 / 8.4
HT Nut Assemblies minimum tightening torque (inch lbs./Nm)	14 / 1.6	14 / 1.6	18 / 2.0	18 / 2.0	50 / 5.7	NA

Parflare PFA Tube Fittings

Adaptor Male Straight

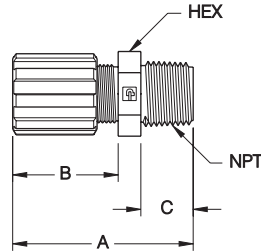

Part Number	Tube Size	NPT Size	Orifice		A		B		C		Hex Size
			inch	mm	inch	mm	inch	mm	inch	mm	
FAMS-42	1/4	1/8	0.13	3.30	2.01	51.05	1.16	29.46	0.55	13.97	5/8
FAMS-44	1/4	1/4	0.13	3.30	2.01	51.05	1.16	29.46	0.55	13.97	5/8
FAMS-46	1/4	3/8	0.12	3.05	2.01	51.05	1.16	29.46	0.55	13.97	11/16
FAMS-48	1/4	1/2	0.12	3.05	2.15	54.61	1.16	29.46	0.66	16.76	13/16
FAMS-412	1/4	3/4	0.12	3.05	2.11	53.59	1.16	29.46	0.67	17.02	1 3/16
FAMS-62	3/8	1/8	0.20	5.08	2.08	52.83	1.24	31.50	0.55	13.97	13/16
FAMS-64	3/8	1/4	0.25	6.35	2.08	52.83	1.24	31.50	0.55	13.97	13/16
FAMS-66	3/8	3/8	0.25	6.35	2.08	52.83	1.24	31.50	0.55	13.97	13/16
FAMS-68	3/8	1/2	0.25	6.35	2.20	55.88	1.24	31.50	0.66	16.76	15/16
FAMS-612	3/8	3/4	0.25	6.35	2.18	55.37	1.24	31.50	0.65	16.51	1 3/16
FAMS-616	3/8	1	0.24	6.10	2.35	59.69	1.24	31.50	0.83	21.08	1 7/16
FAMS-82	1/2	1/8	0.20	5.08	2.19	55.63	1.37	34.80	0.55	13.97	15/16
FAMS-84	1/2	1/4	0.28	7.11	2.18	55.37	1.34	34.04	0.55	13.97	15/16
FAMS-86	1/2	3/8	0.38	9.65	2.17	55.12	1.33	33.78	0.55	13.97	15/16
FAMS-88	1/2	1/2	0.38	9.65	2.30	58.42	1.34	34.04	0.66	16.76	15/16
FAMS-812	1/2	3/4	0.38	9.65	2.28	57.91	1.34	34.04	0.66	16.76	1 3/16
FAMS-816	1/2	1	0.37	9.40	2.43	61.72	1.34	34.04	0.85	21.59	1 7/16
FAMS-128	3/4	1/2	0.53	13.46	2.42	61.47	1.46	37.08	0.66	16.76	1 3/16
FAMS-1212	3/4	3/4	0.62	15.75	2.42	61.47	1.46	37.08	0.66	16.76	1 3/16
FAMS-1216	3/4	1	0.62	15.75	2.62	66.55	1.48	37.59	0.85	21.59	1 7/16
FAMS-168	1	1/2	0.53	13.46	2.72	69.09	1.78	45.21	0.66	16.76	1 7/16
FAMS-1612	1	3/4	0.66	16.76	2.72	69.09	1.76	44.70	0.67	17.02	1 7/16
FAMS-1616	1	1	0.88	22.35	2.92	74.17	1.78	45.21	0.85	21.59	1 7/16
FAMS-1620	1	1 1/4	0.88	22.35	2.97	75.43	1.80	45.72	0.88	22.35	1 3/4
FAMS-2016	1 1/4	1	1.09	27.68	3.51	89.15	2.16	54.86	0.85	21.59	N/A
FAMS-2020	1 1/4	1 1/4	1.09	27.68	3.54	89.92	2.16	54.86	0.88	22.35	N/A

Adaptor Male Straight Redi-flare

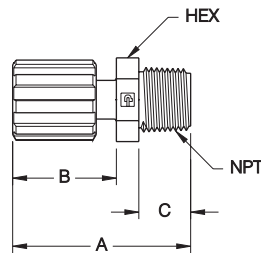

Part Number	Tube Size	NPT Size	Orifice		A		B		C		Hex Size
			inch	mm	inch	mm	inch	mm	inch	mm	
FAMS-8RF4	1/2	1/4	0.38	9.65	2.18	55.37	1.34	34.04	0.55	13.97	15/16
FAMS-8RF6	1/2	3/8	0.38	9.65	2.18	55.37	1.34	34.04	0.55	13.97	15/16
FAMS-12RF8	3/4	1/2	0.62	15.75	2.53	64.26	1.55	39.37	0.67	17.01	15/16
FAMS-12RF12	3/4	3/4	0.62	15.75	2.48	62.99	1.55	39.37	0.65	16.51	1 3/16

Parflare PFA Tube Fittings

Adaptor Male Straight Panel Mount

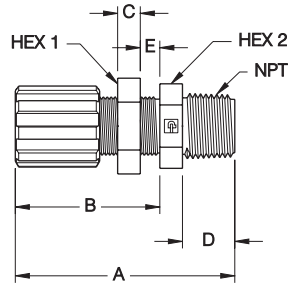

Part Number	Tube Size	NPT Size	Orifice		A		B		C		D		E (max.)		Hole Size		Hex 1 Size	Hex 2 Size
			inch	mm	inch	mm	inch	mm	inch	mm	inch	mm	inch	mm	inch	mm		
FAMS-42-P	1/4	1/8	0.13	3.30	2.54	64.52	1.70	43.18	0.29	7.37	0.55	13.97	0.25	6.35	0.50	12.70	11/16	11/16
FAMS-44-P	1/4	1/4	0.13	3.30	2.54	64.52	1.71	43.43	0.29	7.37	0.55	13.97	0.25	6.35	0.50	12.70	11/16	11/16
FAMS-64-P	3/8	1/4	0.25	6.35	2.56	65.02	1.72	43.67	0.55	13.97	0.55	13.97	0.50	12.70	0.63	16.00	15/16	13/16
FAMS-66-P	3/8	3/8	0.25	6.35	2.57	65.28	1.73	43.94	0.29	7.37	0.55	13.97	0.25	6.35	0.63	16.00	15/16	13/16
FAMS-84-P	1/2	1/4	0.28	7.11	2.66	67.56	1.82	46.23	0.29	7.37	0.55	13.97	0.25	6.35	0.75	19.05	1 1/16	15/16
FAMS-86-P	1/2	3/8	0.37	9.40	2.65	67.31	1.81	45.97	0.29	7.37	0.54	13.72	0.25	6.35	0.75	19.05	1 1/16	15/16
FAMS-88-P	1/2	1/2	0.38	9.65	2.78	70.61	1.83	46.48	0.29	7.37	0.66	16.76	0.25	6.35	0.75	19.05	1 1/16	15/16
FAMS-1212-P	3/4	3/4	0.63	16.00	3.08	78.23	2.12	53.85	0.29	7.37	0.66	16.76	0.50	12.70	1.00	25.40	1 5/16	1 3/16
FAMS-1616-P	1	1	0.87	22.10	3.18	80.77	2.05	52.07	0.29	7.37	0.85	21.59	0.50	12.70	1.44	36.58	1 3/4	1 3/4

Adaptor Male Straight Panel Mount, Extended

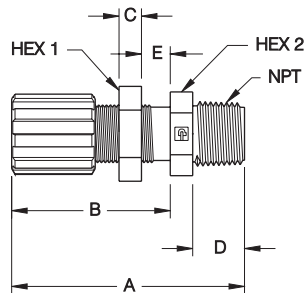

Part Number	Tube Size	NPT Size	Orifice		A		B		C		D		E (max.)		Hole Size		Hex 1 Size	Hex 2 Size
			inch	mm	inch	mm	inch	mm	inch	mm	inch	mm	inch	mm	inch	mm		
FAMS-44-PX	1/4	1/4	0.12	3.05	2.69	68.33	1.85	46.99	0.29	7.37	0.55	13.97	0.50	12.70	0.50	12.70	11/16	11/16
FAMS-66-PX	3/8	3/8	0.25	6.35	2.73	69.34	1.90	48.26	0.29	7.37	0.55	13.97	0.50	12.70	0.63	16.00	15/16	13/16
FAMS-86-PX	1/2	3/8	0.38	9.65	2.87	72.90	2.03	51.56	0.29	7.37	0.55	13.97	0.50	12.70	0.75	19.05	1 1/16	15/16
FAMS-88-PX	1/2	1/2	0.37	9.40	2.99	75.95	2.05	52.07	0.29	7.37	0.66	16.76	0.50	12.70	0.75	19.05	1 1/16	15/16
FAMS-1212-PX	3/4	3/4	0.63	16.00	3.10	78.74	2.10	54.40	0.30	7.62	0.67	17.02	0.50	12.70	1.00	25.40	1 5/16	1 3/16

Adaptor Female Straight

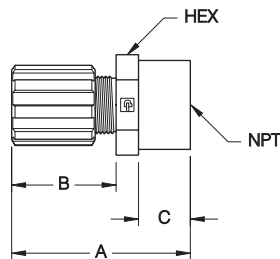

Part Number	Tube Size	NPT Size	Orifice		A		B		C		Hex Size
			inch	mm	inch	mm	inch	mm	inch	mm	
FAFS-42	1/4	1/8	0.12	3.11	2.03	52.58	1.18	30.56	0.56	14.50	5/8
FAFS-44	1/4	1/4	0.12	3.11	2.03	52.58	1.18	30.56	0.56	14.50	3/4
FAFS-46	1/4	3/8	0.12	3.11	2.04	52.84	1.20	31.08	0.56	14.50	15/16
FAFS-48	1/4	1/2	0.12	3.11	2.11	54.65	1.16	30.04	0.67	17.35	1 3/16

Parflare PFA Tube Fittings

Adaptor Female Straight cont.

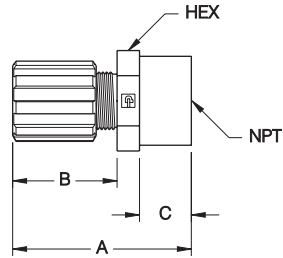

Part Number	Tube Size	NPT Size	Orifice		A		B		C		Hex Size
			inch	mm	inch	mm	inch	mm	inch	mm	
FAFS-62	3/8	1/8	0.25	6.48	2.08	53.87	1.23	31.86	0.56	14.50	5/8
FAFS-64	3/8	1/4	0.25	6.48	2.10	54.39	1.25	32.38	0.56	14.50	3/4
FAFS-66	3/8	3/8	0.25	6.48	2.07	53.61	1.22	31.60	0.56	14.50	15/16
FAFS-68	3/8	1/2	0.25	6.35	2.17	56.20	1.21	31.34	0.67	17.35	1
FAFS-84	1/2	1/4	0.31	8.03	2.20	56.98	1.33	34.45	0.56	14.50	3/4
FAFS-86	1/2	3/8	0.37	9.58	2.19	56.72	1.34	34.71	0.63	16.32	15/16
FAFS-88	1/2	1/2	0.37	9.58	2.31	59.83	1.34	34.71	0.67	17.35	1 1/8
FAFS-812	1/2	3/4	0.37	9.58	2.36	61.12	1.40	36.26	0.67	17.35	1 3/16
FAFS-816	1/2	1	0.37	9.58	2.56	66.30	1.40	36.26	0.86	22.27	1 5/8
FAFS-128	3/4	1/2	0.57	14.76	2.45	63.46	1.50	38.85	0.66	17.09	1 3/16
FAFS-1212	3/4	3/4	0.62	16.06	2.43	62.94	1.46	37.81	0.67	17.35	1 3/16
FAFS-1216	3/4	1	0.62	16.06	2.63	68.12	1.48	38.33	0.86	22.27	1 5/8
FAFS-168	1	1/2	0.55	14.25	2.74	70.97	1.79	46.36	0.67	17.35	1 5/8
FAFS-1612	1	3/4	0.76	19.68	2.74	70.97	1.78	46.10	0.68	17.61	1 5/8
FAFS-1616	1	1	0.87	22.53	2.93	75.89	1.78	46.10	0.86	22.27	1 5/8

Adaptor Female Straight Panel Mount

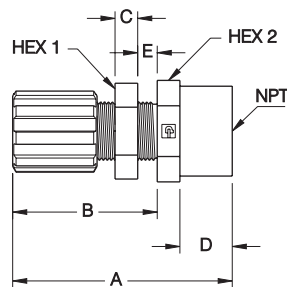

Part Number	Tube Size	NPT Size	Orifice		A		B		C		D		E (max.)		Hole Size		Hex 1 Size	Hex 2 Size
			inch	mm	inch	mm	inch	mm	inch	mm	inch	mm	inch	mm	inch	mm		
FAFS-44-P	1/4	1/4	0.12	3.05	2.52	64.01	1.67	42.42	0.29	7.37	0.56	14.22	0.25	6.35	0.50	12.70	11/16	3/4
FAFS-64-P	3/8	1/4	0.12	3.05	2.58	65.53	1.72	43.69	0.29	7.37	0.57	14.48	0.25	6.35	0.63	16.00	15/16	3/4
FAFS-66-P	3/8	3/8	0.25	6.35	2.63	66.80	1.72	43.69	0.29	7.37	0.62	15.75	0.25	6.35	0.63	16.00	15/16	15/16
FAFS-88-P	1/2	1/2	0.38	9.65	2.81	71.37	1.85	46.99	0.29	7.37	0.67	17.02	0.25	6.35	0.75	19.05	1 1/16	1 1/8
FAFS-1212-P	3/4	3/4	0.63	16.00	3.16	80.26	2.11	53.59	0.29	7.37	0.76	19.30	0.50	12.70	1.00	25.40	1 5/16	1 3/16
FAFS-1616-P	1	1	0.88	22.35	3.50	88.90	2.35	59.69	0.29	7.37	0.86	21.84	0.50	12.70	1.44	36.58	1 3/4	1 3/4

Parflare PFA Tube Fittings

Straight Connector

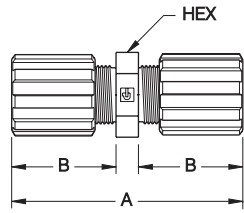

Part Number	Tube Size	Orifice		A		B		Hex Size
		inch	mm	inch	mm	inch	mm	
FSC-4	1/4	0.12	3.05	2.59	65.79	1.14	28.96	11/16
FSC-6	3/8	0.25	6.35	2.79	70.87	1.25	31.75	13/16
FSC-8	1/2	0.38	9.65	2.96	75.18	1.33	33.78	15/16
FSC-12	3/4	0.62	15.75	3.20	81.28	1.45	36.83	1 3/16
FSC-16	1	0.87	22.10	3.83	97.28	1.77	44.96	1 7/16
FSC-20	1 1/4	1.10	27.94	4.83	122.68	2.16	54.86	N/A

Straight Connector Panel Mount

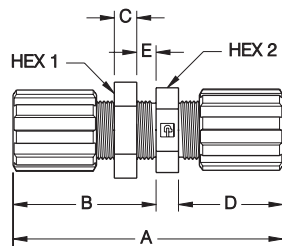

Part Number	Tube Size	Orifice		A		B		C		D		E (max.)		Hole Size		Hex 1 Size	Hex 2 Size
		inch	mm	inch	mm	inch	mm	inch	mm	inch	mm	inch	mm	inch	mm		
FSC-4-P	1/4	0.12	3.05	3.21	81.53	1.70	43.18	0.29	7.37	1.21	30.73	0.25	6.45	0.50	12.70	11/16	11/16
FSC-6-P	3/8	0.25	6.35	3.29	83.57	1.75	44.45	0.29	7.37	1.25	31.75	0.25	6.35	0.63	16.00	15/16	13/16
FSC-8-P	1/2	0.38	9.65	3.46	87.88	1.83	46.48	0.29	7.37	1.34	34.04	0.25	6.35	0.75	19.05	1 1/16	15/16
FSC-12-P	3/4	0.62	15.75	3.84	97.54	2.08	52.83	0.29	7.37	1.46	37.08	0.25	6.35	1.00	25.40	1 3/16	1 3/16
FSC-16-P	1	0.87	22.10	4.43	112.52	2.37	60.20	0.29	7.37	1.78	45.21	0.50	12.70	1.44	36.58	1 3/4	1 3/4

Straight Connector Panel Mount, Extended

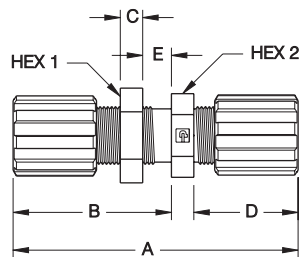

Part Number	Tube Size	Orifice		A		B		C		D		E (max.)		Hole Size		Hex 1 Size	Hex 2 Size
		inch	mm	inch	mm	inch	mm	inch	mm	inch	mm	inch	mm	inch	mm		
FSC-4-PX	1/4	0.12	3.05	3.29	83.57	1.86	47.24	0.29	7.37	1.14	28.96	0.50	12.70	0.50	12.70	11/16	11/16
FSC-6-PX	3/8	0.25	6.35	3.47	88.14	1.94	49.28	0.29	7.37	1.24	31.50	0.50	12.70	0.63	16.00	15/16	13/16
FSC-8-PX	1/2	0.38	9.65	3.67	93.22	2.04	51.82	0.29	7.37	1.36	34.54	0.50	12.70	0.75	19.05	1 1/16	15/16
FSC-12-PX	3/4	0.62	15.75	3.85	97.80	2.11	53.59	0.29	7.37	1.45	36.83	0.50	12.70	1.00	25.40	1 3/16	1 3/16

Parflare PFA Tube Fittings

Straight Connector Reducer

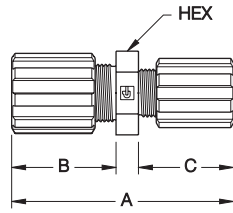

Part Number	Tube Size	Orifice		A		B		C		Hex Size
		inch	mm	inch	mm	inch	mm	inch	mm	
FSCR-64	3/8 X 1/4	0.12	3.05	2.69	68.33	1.21	30.73	1.18	29.97	13/16
FSCR-84	1/2 X 1/4	0.13	3.30	2.82	71.63	1.38	35.05	1.15	29.21	15/16
FSCR-86	1/2 X 3/8	0.25	6.35	2.84	72.14	1.34	34.04	1.22	30.99	15/16
FSCR-124	3/4 X 1/4	0.12	3.05	2.69	68.33	1.43	36.32	1.14	28.96	1 3/16
FSCR-126	3/4 X 3/8	0.25	6.35	2.93	74.42	1.43	36.32	1.21	30.73	1 3/16
FSCR-128	3/4 X 1/2	0.38	9.65	3.08	78.23	1.45	36.83	1.33	33.78	1 3/16
FSCR-168	1 X 1/2	0.37	9.40	3.39	86.11	1.77	44.96	1.33	33.78	1 7/16
FSCR-1612	1 X 3/4	0.62	15.75	3.51	89.15	1.78	45.21	1.45	36.83	1 7/16
FSCR-2016	1 1/4 X 1	0.87	22.10	4.43	112.52	2.16	54.86	1.77	44.96	N/A

Straight Connector Reducer, Redi-flare

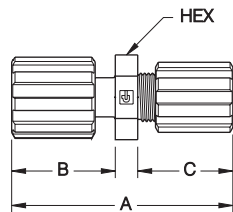

Part Number	Tube Size	Orifice		A		B		C		Hex Size
		inch	mm	inch	mm	inch	mm	inch	mm	
FSCR-6RF4	3/8 RF X 1/4 F	0.12	3.05	2.68	68.07	1.23	31.24	1.16	29.46	11/16
FSCR-8RF4	1/2 RF X 1/4 F	0.12	3.05	2.78	70.61	1.32	33.53	1.15	29.21	11/16
FSCR-8RF6	1/2 RF X 3/8 F	0.25	6.35	2.71	68.83	1.20	30.48	1.22	30.99	5/8
FSCR-86RF	1/2 F X 3/8 RF	0.25	6.35	2.89	73.41	1.25	31.75	1.35	34.29	15/16
FSCR-12RF4	3/4 RF X 1/4 F	0.12	3.05	2.97	75.44	1.52	38.61	1.16	29.46	15/16
FSCR-12RF6	3/4 RF X 3/8 F	0.25	6.35	3.10	78.74	1.59	40.39	1.22	30.99	15/16
FSCR-12RF8	3/4 RF X 1/2 F	0.38	9.65	3.18	80.77	1.54	39.12	1.35	34.29	15/16
FSCR-128RF	3/4 F X 1/2 RF	0.38	9.65	3.09	78.49	1.34	34.04	1.46	37.08	1 3/16
FSCR-16RF8	1 RF X 1/2 F	0.38	9.65	3.67	93.22	2.03	51.56	1.35	34.29	1 7/16
FSCR-168RF	1 F X 1/2 RF	0.38	9.65	3.43	87.12	1.34	34.04	1.80	45.72	1 7/16
FSCR-16RF12	1 RF X 3/4 F	0.63	16.00	3.87	98.30	2.03	51.56	1.55	39.37	1 3/16
FSCR-1612RF	1 F X 3/4 RF	0.63	16.00	3.66	92.96	1.57	39.88	1.80	45.72	1 7/16

Straight Connector Reducer, Redi-flare

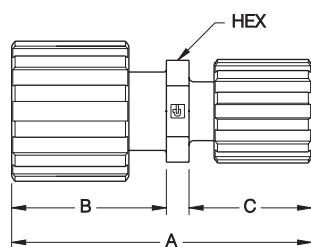

Part Number	Tube Size	Orifice		A		B		C		Hex Size
		inch	mm	inch	mm	inch	mm	inch	mm	
FSCR-16RF12RF	1 X 3/4	0.63	16.00	3.84	97.54	1.98	50.29	1.57	39.88	1 1/8

Parflare PFA Tube Fittings

Straight Connector Reducer, Pargrip

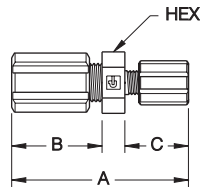

Part Number	Tube Size	Orifice		A		B		C		Hex Size
		inch	mm	inch	mm	inch	mm	inch	mm	
FSCR-42G	1/4 X 1/8	0.09	2.29	2.19	55.63	1.15	29.21	0.75	19.05	11/16

Straight Connector Reducer, Redi-flare Pargrip

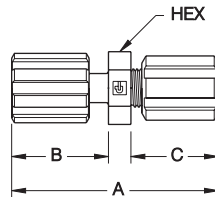

Part Number	Tube Size	Orifice		A		B		C		Hex Size
		inch	mm	inch	mm	inch	mm	inch	mm	
FSCR-4RF2G	1/4 X 1/8	0.09	2.29	2.22	56.39	1.18	29.97	0.75	19.05	11/16
FSCR-6RF4G	3/8 X 1/4	0.13	3.30	2.67	67.82	1.25	31.75	1.13	28.70	11/16

Straight Connector Reducer Panel Mount

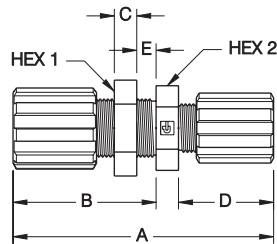

Part Number	Tube Size	Orifice		A		B		C		D		E (max.)		Hole Size		Hex 1 Size	Hex 2 Size
		inch	mm	inch	mm	inch	mm	inch	mm	inch	mm	inch	mm	inch	mm		
FSCR-64-P	3/8 X 1/4	0.12	3.05	3.18	80.77	1.73	43.94	0.29	7.37	1.16	29.46	0.25	6.35	0.63	16.00	15/16	13/16
FSCR-84-P	1/2 X 1/4	0.12	3.05	3.25	82.55	1.83	46.48	0.29	7.37	1.13	28.70	0.25	6.35	0.75	19.05	1 1/16	15/16
FSCR-86-P	1/2 X 3/8	0.25	6.35	3.37	85.60	1.86	47.24	0.29	7.37	1.22	30.99	0.25	6.35	0.75	19.05	1 1/16	15/16
FSCR-126-P	3/4 X 3/8	0.25	6.35	3.63	92.20	2.11	53.59	0.29	7.37	1.23	31.24	0.50	12.7	1.00	25.40	1 5/16	1 3/16
FSCR-128-P	3/4 X 1/2	0.38	9.65	3.71	94.23	2.09	53.09	0.29	7.37	1.33	33.78	0.25	6.35	1.00	25.40	1 5/16	1 3/16
FSCR-1216-P	3/4 X 1	0.63	16.00	4.15	105.41	2.10	53.34	0.29	7.37	1.76	44.70	0.25	6.35	1.00	25.40	1 5/16	1 7/16
FSCR-1612-P	1 X 3/4	0.62	15.85	4.08	103.63	2.34	59.44	0.29	7.37	1.46	37.08	0.50	12.7	1.44	36.58	1 3/4	1 3/4

Parflare PFA Tube Fittings

Straight Connector Reducer Panel Mount, Extended

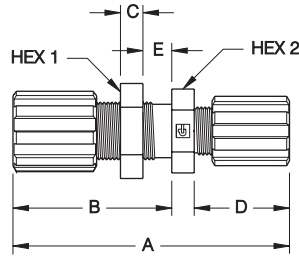

Part Number	Tube Size	Orifice		A		B		C		D		E (max.)		Hole Size		Hex 1 Size	Hex 2 Size
		inch	mm	inch	mm	inch	mm	inch	mm	inch	mm	inch	mm	inch	mm		
FSCR-86-PX	1/2 X 3/8	0.25	6.35	3.55	90.17	2.04	51.82	0.29	7.37	1.22	30.99	0.50	12.7	0.75	19.05	1 1/16	15/16

Adaptor Male Elbow

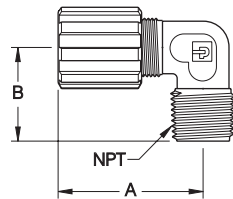

Part Number	Tube Size	NPT Size	Orifice		A		B	
			inch	mm	inch	mm	inch	mm
FAME-42	1/4	1/8	0.12	5.08	1.70	43.18	1.08	27.43
FAME-44	1/4	1/4	0.12	3.05	1.68	42.67	1.08	27.43
FAME-46	1/4	3/8	0.12	3.05	1.67	42.42	1.08	27.43
FAME-48	1/4	1/2	0.12	3.05	1.68	42.67	1.20	30.48
FAME-62	3/8	1/8	0.25	6.35	1.77	44.96	1.08	27.43
FAME-64	3/8	1/4	0.25	6.35	1.74	44.20	1.08	27.43
FAME-66	3/8	3/8	0.25	6.35	1.75	44.45	1.08	27.43
FAME-68	3/8	1/2	0.25	6.35	1.77	44.96	1.18	29.97
FAME-612	3/8	3/4	0.25	6.35	1.89	48.01	1.36	34.54
FAME-84	1/2	1/4	0.38	9.65	1.86	47.24	1.07	27.18
FAME-86	1/2	3/8	0.38	9.65	1.93	49.02	1.08	27.43
FAME-88	1/2	1/2	0.38	9.65	1.86	47.24	1.19	30.23
FAME-812	1/2	3/4	0.38	9.65	2.04	51.82	1.37	34.80
FAME-128	3/4	1/2	0.54	13.72	2.17	55.12	1.37	34.80
FAME-1212	3/4	3/4	0.63	16.00	2.16	54.86	1.37	34.80
FAME-1216	3/4	1	0.63	16.00	2.30	58.42	1.81	45.97
FAME-1612	1	3/4	0.66	16.76	2.78	70.61	1.64	41.66
FAME-1616	1	1	0.88	22.35	2.75	69.85	1.82	46.23

Adaptor Male Elbow, Redi-flare

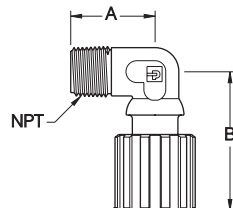

Part Number	Tube Size	NPT Size	Orifice		A		B	
			inch	mm	inch	mm	inch	mm
FAME-4RF4	1/4	1/4	0.12	3.30	1.07	27.18	1.70	43.18
FAME-12RF12	3/4	3/4	0.63	16.00	1.36	34.54	2.27	57.66
FAME-16RF16	1	1	0.88	22.35	1.87	47.50	2.95	74.93

Parflare PFA Tube Fittings

Adaptor Female Elbow

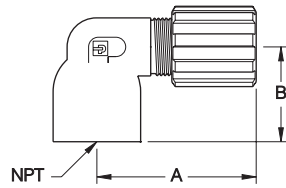

Part Number	Tube Size	NPT Size	Orifice		A		B	
			inch	mm	inch	mm	inch	mm
FAFE-42	1/4	1/8	0.12	3.05	1.89	48.01	0.84	21.34
FAFE-44	1/4	1/4	0.12	3.05	1.87	47.50	0.98	24.89
FAFE-64	3/8	1/4	0.25	6.35	1.96	49.78	0.98	24.89
FAFE-66	3/8	3/8	0.25	6.35	1.77	44.96	0.98	24.89
FAFE-68	3/8	1/2	0.25	6.35	1.96	49.78	1.24	31.50
FAFE-84	1/2	1/4	0.31	7.87	2.10	53.34	0.98	24.89
FAFE-86	1/2	3/8	0.38	9.65	2.11	53.59	0.99	25.15
FAFE-88	1/2	1/2	0.38	9.65	2.05	52.07	1.25	31.75
FAFE-128	3/4	1/2	0.63	16.00	2.38	60.45	1.69	42.93
FAFE-1212	3/4	3/4	0.63	16.00	2.47	62.74	2.19	55.63
FAFE-1616	1	1	0.88	22.35	2.74	69.60	1.60	40.64

Elbow Connector

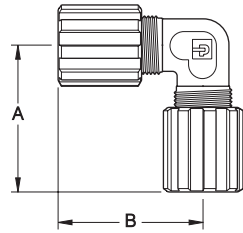

Part Number	Tube Size	Orifice		A		B	
		inch	mm	inch	mm	inch	mm
FEC-4	1/4	0.12	3.05	1.69	42.93	1.69	42.93
FEC-6	3/8	0.25	6.35	1.77	44.96	1.77	44.96
FEC-8	1/2	0.38	9.65	1.91	48.51	1.91	48.51
FEC-12	3/4	0.63	16.00	2.14	54.36	2.14	54.36
FEC-16	1	0.87	22.10	2.75	69.85	2.75	69.85
FEC-20	1 1/4	1.09	27.69	3.42	86.87	3.42	86.87

Elbow Connector Redi-flare

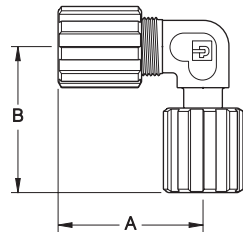

Part Number	Tube Size	Orifice		A		B	
		inch	mm	inch	mm	inch	mm
FEC-44RF	1/4 X 1/4	0.12	3.05	1.73	43.94	1.60	40.64
FEC-66RF	3/8 X 3/8	0.25	6.35	1.76	44.70	1.70	43.18
FEC-88RF	1/2 X 1/2	0.38	9.65	1.86	47.24	1.80	45.72
FEC-1212RF	3/4 X 3/4	0.63	16.00	2.15	54.61	2.20	55.88
FEC-1616RF	1 X 1	0.87	22.10	2.56	65.02	2.80	71.12
FEC-2020RF	1 1/4 X 1 1/4	1.10	27.94	3.42	86.87	3.67	93.22

Parflare PFA Tube Fittings

Elbow Connector Redi-flare

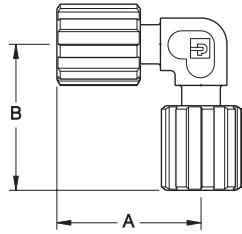

Part Number	Tube Size	Orifice		A		B	
		inch	mm	inch	mm	inch	mm
FEC-4RF	1/4	0.16	4.06	1.70	43.18	1.70	43.18
FEC-6RF	3/8	0.25	6.35	1.76	44.70	1.76	44.70
FEC-8RF	1/2	0.38	9.65	1.74	44.20	1.74	44.20
FEC-12RF	3/4	0.62	15.75	2.30	58.42	2.30	58.42
FEC-16RF	1	0.87	22.10	2.85	72.39	2.85	72.39

Elbow Connector Panel Mount

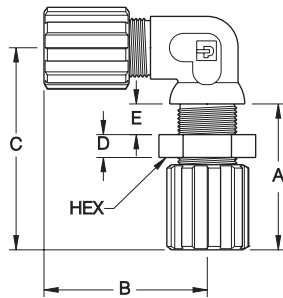

Part Number	Tube Size	Orifice		A		B		C		D		E (max.)		Hole Size		Hex Size
		inch	mm	inch	mm	inch	mm	inch	mm	inch	mm	inch	mm	inch	mm	
FEC-4-P	1/4	0.12	3.05	1.68	42.67	1.70	43.18	2.21	56.13	0.29	7.37	0.25	6.35	0.50	12.70	11/16
FEC-6-P	3/8	0.25	6.35	1.75	44.45	1.95	49.53	2.45	62.23	0.29	7.37	0.25	6.35	0.63	16.00	15/16
FEC-8-P	1/2	0.38	9.65	1.85	46.99	1.90	48.26	2.56	65.02	0.29	7.37	0.25	6.35	0.75	19.05	1 1/16

Elbow Connector Panel Mount, Extended

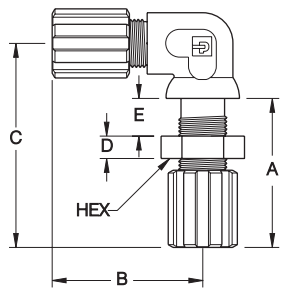

Part Number	Tube Size	Orifice		A		B		C		D		E (max.)		Hole Size		Hex Size
		inch	mm	inch	mm	inch	mm	inch	mm	inch	mm	inch	mm	inch	mm	
FEC-4-PX	1/4	0.12	3.05	1.86	47.24	1.66	42.16	2.38	60.45	0.29	7.37	0.50	12.70	0.50	12.70	11/16
FEC-6-PX	3/8	0.25	6.35	1.89	48.01	1.88	47.75	2.60	66.04	0.29	7.37	0.50	12.70	0.63	16.00	15/16

Parflare PFA Tube Fittings

Elbow Connector Reducer

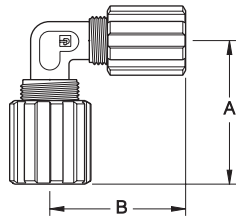

Part Number	Tube Size	Orifice		A		B	
		inch	mm	inch	mm	inch	mm
FECR-64	3/8 X 1/4	0.12	3.05	1.75	44.45	1.71	43.43
FECR-84	1/2 X 1/4	0.13	3.30	1.87	47.50	1.68	42.67
FECR-86	1/2 X 3/8	0.25	6.35	1.87	47.50	1.77	44.96
FECR-124	3/4 X 1/4	0.12	3.05	2.18	55.37	1.89	48.01
FECR-126	3/4 X 3/8	0.25	6.35	2.16	54.86	1.95	49.53
FECR-128	3/4 X 1/2	0.38	9.65	2.17	55.12	2.10	53.34
FECR-1612	1 X 3/4	0.62	15.75	2.75	69.85	2.39	60.71
FECR-2016	1 1/4 X 1	0.88	22.35	2.80	71.12	3.42	86.87

Elbow Connector Reducer, Redi-flare

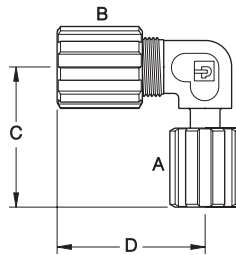

Part Number	A	B	Orifice		C		D	
	Tube Size		inch	mm	inch	mm	inch	mm
FECR-6RF4	3/8	1/4	0.13	3.30	1.76	44.70	1.66	42.16
FECR-64RF	1/4	3/8	0.15	3.81	1.69	42.93	1.74	44.20
FECR-8RF6	1/2	3/8	0.25	6.35	1.77	44.96	1.80	45.72
FECR-86RF	3/8	1/2	0.38	9.65	1.86	47.24	1.88	47.75
FECR-12RF8	3/4	1/2	0.38	9.65	2.28	57.91	2.07	52.58
FECR-128RF	1/2	3/4	0.38	9.65	2.04	51.82	2.16	54.86

Elbow Connector Reducer, Redi-flare

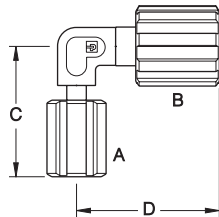

Part Number	A	B	Orifice		C		D	
	Tube Size		inch	mm	inch	mm	inch	mm
FECR-6RF4RF	1/4	3/8	0.15	3.81	1.69	42.93	1.76	44.70
FECR-8RF4RF	1/4	1/2	0.15	3.81	1.69	42.93	1.85	46.99

Adaptor Male Tee

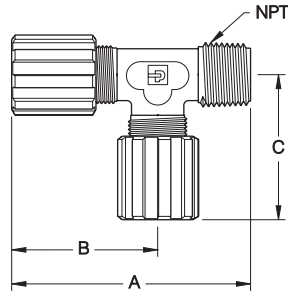

Part Number	Tube Size	NPT Size	Orifice		A		B		C	
			inch	mm	inch	mm	inch	mm	inch	mm
FAMT-424	1/4 X 1/4	1/8	0.12	3.05	2.78	70.61	1.70	43.18	1.68	42.67
FAMT-444	1/4 X 1/4	1/4	0.12	3.05	2.77	70.36	1.68	42.67	1.68	42.67
FAMT-626	3/8 X 3/8	1/8	0.20	5.08	2.82	71.63	1.73	43.94	1.73	43.94
FAMT-646	3/8 X 3/8	1/4	0.25	6.35	2.80	71.12	1.73	43.94	1.73	43.94
FAMT-666	3/8 X 3/8	3/8	0.25	6.35	2.82	71.63	1.73	43.94	1.73	43.94
FAMT-686	3/8 X 3/8	1/2	0.25	6.35	2.91	73.91	1.72	43.69	1.73	43.94
FAMT-848	1/2 X 1/2	1/4	0.29	7.37	2.94	74.68	1.87	47.50	1.88	47.75
FAMT-868	1/2 X 1/2	3/8	0.38	9.65	2.89	73.41	1.83	46.48	1.83	46.48
FAMT-888	1/2 X 1/2	1/2	0.38	9.65	3.04	77.22	1.84	46.74	1.84	46.74
FAMT-12812	3/4 X 3/4	1/2	0.53	13.46	3.45	87.63	2.08	52.83	2.08	52.83
FAMT-12128	3/4 X 1/2	3/4	0.38	9.65	3.48	88.39	2.14	54.36	2.03	51.56
FAMT-121212	3/4 X 3/4	3/4	0.61	15.49	3.43	87.12	2.06	52.32	2.07	52.58

Branch Male Tee

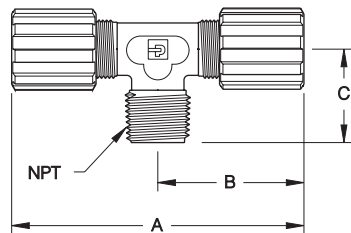

Part Number	Tube Size	NPT Size	Orifice		A		B		C	
			inch	mm	inch	mm	inch	mm	inch	mm
FBMT-442	1/4 X 1/4	1/8	0.12	3.05	3.47	88.14	1.73	43.94	1.08	27.43
FBMT-444	1/4 X 1/4	1/4	0.12	3.05	3.35	85.09	1.67	42.42	1.07	27.18
FBMT-662	3/8 X 3/8	1/8	0.20	5.08	3.52	89.41	1.76	44.70	1.07	27.18
FBMT-664	3/8 X 3/8	1/4	0.25	6.35	3.48	88.39	1.74	44.20	1.07	27.18
FBMT-666	3/8 X 3/8	3/8	0.25	6.35	3.46	87.88	1.73	43.94	1.07	27.18
FBMT-668	3/8 X 3/8	1/2	0.25	6.35	3.48	88.39	1.73	43.94	1.18	29.97
FBMT-884	1/2 X 1/2	1/4	0.29	7.37	3.72	94.49	1.86	47.24	1.08	27.43
FBMT-886	1/2 X 1/2	3/8	0.38	9.65	3.71	94.23	1.85	46.99	1.07	27.18
FBMT-888	1/2 X 1/2	1/2	0.38	9.65	3.70	93.98	1.85	46.99	1.18	29.97
FBMT-12124	3/4 X 3/4	1/4	0.29	7.24	4.17	105.92	2.08	52.83	1.26	32.00
FBMT-12128	3/4 X 3/4	1/2	0.52	13.21	4.19	106.43	2.09	53.09	1.37	34.80
FBMT-121212	3/4 X 3/4	3/4	0.62	15.75	4.20	106.68	2.10	53.34	1.37	34.80
FBMT-16164	1 X 1	1/4	0.28	7.11	5.50	139.70	2.75	69.85	1.55	39.37

Parflare PFA Tube Fittings

Branch Male Tee Reducer

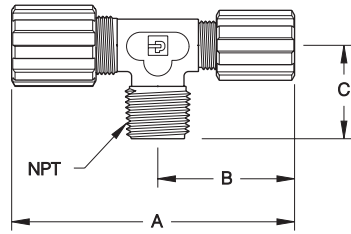

Part Number	Tube Size	NPT Size	Orifice		A		B		C	
			inch	mm	inch	mm	inch	mm	inch	mm
FBMTR-644	3/8 X 1/4	1/4	0.12	3.05	3.44	87.38	1.69	42.93	1.08	27.43
FBMTR-646	3/8 X 1/4	3/8	0.12	3.05	3.43	87.12	1.69	42.93	1.08	27.43
FBMTR-866	1/2 X 3/8	3/8	0.25	6.35	3.59	91.19	1.76	44.70	1.08	27.43
FBMTR-848	1/2 X 1/4	1/2	0.12	3.05	3.52	89.41	1.64	41.66	1.19	30.23

Branch Male Tee Reducer, Pargrip

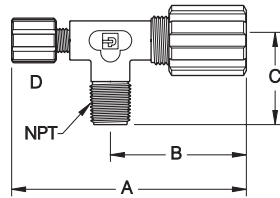

Part Number	Tube Size	NPT Size	D Pargrip Size	Orifice		A		B		C	
				inch	mm	inch	mm	inch	mm	inch	mm
FBMTR-2G64	3/8	1/4	1/8	0.09	2.29	3.03	76.96	1.76	44.70	1.08	27.43
FBMTR-2G66	3/8	3/8	1/8	0.13	3.30	3.40	86.36	1.12	28.45	1.08	27.43

Tee Connector

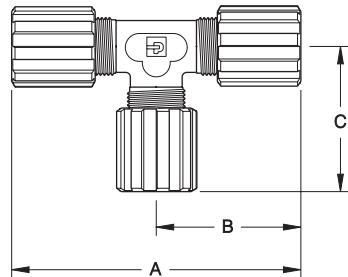

Part Number	Tube Size	Orifice		A		B		C	
		inch	mm	inch	mm	inch	mm	inch	mm
FTC-4	1/4	0.12	3.05	3.36	85.34	1.68	42.67	1.68	42.67
FTC-6	3/8	0.25	6.35	3.52	89.41	1.76	44.70	1.76	44.70
FTC-8	1/2	0.38	9.65	3.69	93.73	1.84	46.74	1.84	46.74
FTC-12	3/4	0.63	16.00	4.30	109.22	2.15	54.61	2.15	54.61
FTC-16	1	0.87	22.10	5.48	139.19	2.74	69.60	2.74	69.60
FTC-20	1 1/4	1.10	27.94	6.85	173.99	3.42	86.87	3.42	86.87

Parflare PFA Tube Fittings

Tee Connector, Redi-flare

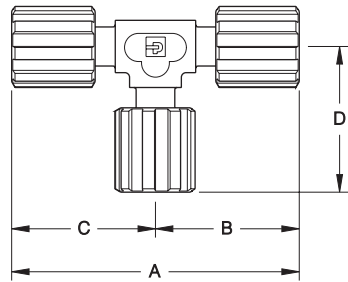

Part Number	Tube Size	Orifice		A		B		C		D	
		inch	mm	inch	mm	inch	mm	inch	mm	inch	mm
FTC-4RF	1/4	0.15	3.81	3.41	86.61	1.71	43.43	1.71	43.43	1.70	43.18
FTC-6RF	3/8	0.25	6.35	3.55	90.17	1.78	45.21	1.78	45.21	1.78	45.21
FTC-8RF	1/2	0.38	9.65	3.70	93.98	1.85	46.99	1.85	46.99	1.85	46.99
FTC-12RF	3/4	0.63	16.00	4.80	121.92	2.40	60.96	2.40	60.96	2.40	60.96
FTC-16RF	1	0.88	22.35	6.01	152.65	3.00	76.20	3.00	76.20	2.99	75.95

Tee Connector Reducer

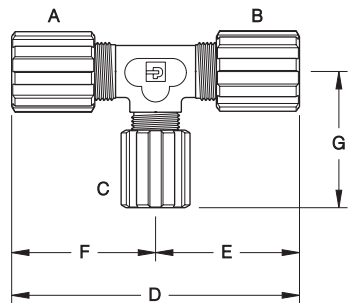

Part Number	A	B	C	Orifice		D		E		F		G	
	Tube Size			inch	mm	inch	mm	inch	mm	inch	mm	inch	mm
FTCR-446	1/4	1/4	3/8	0.12	3.05	3.35	85.09	1.68	42.67	1.68	42.67	1.74	44.20
FTCR-466	1/4	3/8	3/8	0.12	3.05	3.46	87.88	1.74	44.20	1.72	43.69	1.74	44.20
FTCR-448	1/4	1/4	1/2	0.12	3.05	3.30	83.82	1.65	41.91	1.65	41.91	1.86	47.24
FTCR-644	3/8	1/4	1/4	0.12	3.05	3.43	87.12	1.68	42.67	1.76	44.70	1.68	42.67
FTCR-664	3/8	3/8	1/4	0.12	3.05	3.52	89.41	1.76	44.70	1.76	44.70	1.68	42.67
FTCR-668	3/8	3/8	1/2	0.25	6.35	3.48	88.39	1.74	44.20	1.74	44.20	1.85	46.99
FTCR-6612	3/8	3/8	3/4	0.25	6.35	3.80	96.52	1.90	48.26	1.90	48.26	2.18	55.37
FTCR-844	1/2	1/4	1/4	0.12	3.05	3.65	92.71	1.73	43.94	1.92	48.77	1.73	43.94
FTCR-848	1/2	1/4	1/2	0.12	3.05	3.52	89.41	1.69	42.93	1.83	46.48	1.83	46.48
FTCR-884	1/2	1/2	1/4	0.12	3.30	3.72	94.49	1.86	47.24	1.86	47.24	1.67	42.42
FTCR-866	1/2	3/8	3/8	0.25	6.35	3.65	92.71	1.73	43.94	1.92	48.77	1.73	43.94
FTCR-868	1/2	3/8	1/2	0.25	6.35	3.67	93.22	1.78	45.21	1.89	48.01	1.89	48.01
FTCR-886	1/2	1/2	3/8	0.25	6.35	3.70	93.98	1.85	46.99	1.85	46.99	1.73	43.94
FTCR-8812	1/2	1/2	3/4	0.37	9.40	4.12	104.65	2.06	52.32	2.06	52.32	2.19	55.63
FTCR-1288	3/4	1/2	1/2	0.38	9.65	4.11	104.39	2.03	51.56	2.08	52.83	2.03	51.56
FTCR-12124	3/4	3/4	1/4	0.12	3.05	4.19	106.43	2.10	53.34	2.10	53.34	1.85	46.99
FTCR-12126	3/4	3/4	3/8	0.25	6.35	4.32	109.73	2.16	54.86	2.16	54.86	1.92	48.77
FTCR-12128	3/4	3/4	1/2	0.38	9.65	4.30	109.22	2.15	54.61	2.15	54.61	2.04	51.82
FTCR-12612	3/4	3/8	3/4	0.25	6.35	3.99	101.35	1.89	48.01	2.10	53.34	2.10	53.34
FTCR-12812	3/4	1/2	3/4	0.38	9.53	4.17	105.92	2.02	51.31	2.15	54.61	2.15	54.61
FTCR-1688	1	1/2	1/2	0.38	9.65	5.07	128.78	2.31	58.67	2.76	70.10	2.31	58.67
FTCR-161212	1	3/4	3/4	0.63	16.00	5.21	132.33	2.43	61.72	2.77	70.36	2.42	61.47
FTCR-161216	1	3/4	1	0.63	16.00	5.21	132.33	2.43	61.72	2.77	70.36	2.76	70.10
FTCR-16164	1	1	1/4	0.12	3.05	5.52	140.21	2.76	70.10	2.76	70.10	2.11	53.59
FTCR-16166	1	1	3/8	0.25	6.35	5.51	139.95	2.75	69.85	2.75	69.85	2.24	56.90
FTCR-16168	1	1	1/2	0.38	9.65	5.52	140.21	2.76	70.10	2.76	70.10	2.31	58.67
FTCR-161612	1	1	3/4	0.62	15.75	5.49	139.45	2.74	69.60	2.74	69.60	2.42	61.47

Parflare PFA Tube Fittings

Tee Connector Reducer, Redi-flare

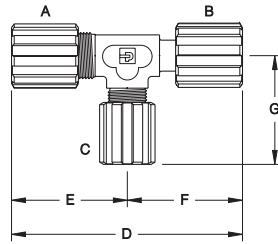

Part Number	A	B	C	Orifice		D		E		F		G	
	Tube Size			inch	mm	inch	mm	inch	mm	inch	mm	inch	mm
FTCR-66RF4	3/8	3/8	1/4	0.12	3.05	3.60	91.44	1.72	43.69	1.78	45.21	1.71	43.43
FTCR-66RF6	3/8	3/8	3/8	0.25	6.35	3.60	91.44	1.74	44.20	1.76	44.70	1.78	45.21
FTCR-8RF68	3/8	1/2	1/2	0.25	6.35	3.61	91.69	1.86	47.24	1.75	44.45	1.88	47.75
FTCR-88RF4	1/2	1/2	1/4	0.12	3.05	3.80	96.52	1.86	47.24	1.80	45.72	1.67	42.42
FTCR-88RF8	1/2	1/2	1/2	0.37	9.40	3.67	93.22	1.84	46.74	1.70	43.18	1.84	46.74
FTCR-128RF12	3/4	1/2	3/4	0.38	9.65	4.00	101.60	2.12	53.85	2.00	50.80	2.12	53.85
FTCR-1212RF4	3/4	3/4	1/4	0.12	3.05	4.45	113.03	2.17	55.12	2.28	57.91	1.83	46.48
FTCR-1212RF6	3/4	3/4	3/8	0.38	9.65	4.30	109.22	2.12	53.85	2.10	53.34	1.91	48.51
FTCR-1212RF8	3/4	3/4	1/2	0.38	9.65	4.45	113.03	2.17	55.12	2.28	57.91	2.03	51.56
FTCR-1212RF12	3/4	3/4	3/4	0.61	15.49	4.60	116.84	2.18	55.37	2.29	58.17	2.18	55.37
FTCR-164RF16	1	1/4	1	0.16	4.06	4.93	125.22	2.78	70.61	2.15	54.61	2.76	70.10
FTCR-1616RF16	1	1	1	0.88	22.35	5.40	137.16	2.77	70.36	2.70	68.58	2.77	70.36

Tee Connector Reducer, Redi-flare

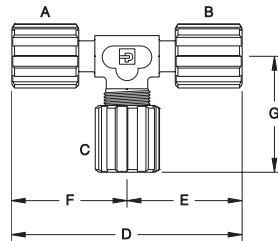

Part Number	A	B	C	Orifice		D		E		F		G	
	Tube Size			inch	mm	inch	mm	inch	mm	inch	mm	inch	mm
FTCR-4RF4RF4	1/4	1/4	1/4	0.12	3.05	3.41	86.61	1.71	43.43	1.71	43.43	1.67	42.42
FTCR-6RF6RF4	3/8	3/8	1/4	0.12	3.05	3.55	90.17	1.78	45.21	1.78	45.21	1.68	42.67
FTCR-6RF6RF6	3/8	3/8	3/8	0.25	6.35	3.50	88.90	1.70	43.18	1.70	43.18	1.70	43.18
FTCR-8RF8RF4	1/2	1/2	1/4	0.12	3.05	3.72	94.49	1.86	47.24	1.86	47.24	1.68	42.67
FTCR-8RF8RF8	1/2	1/2	1/2	0.37	9.40	3.67	93.22	1.83	46.48	1.83	46.48	1.86	47.24
FTCR-8RF8RF12	1/2	1/2	3/4	0.38	9.65	4.00	101.60	2.00	50.80	2.00	50.80	2.16	54.86
FTCR-12RF12RF12	3/4	3/4	3/4	0.61	15.49	4.52	114.81	2.26	57.40	2.26	57.40	2.12	53.85
FTCR-16RF16RF16	1	1	1	0.88	22.35	6.01	152.65	3.01	76.45	3.00	76.20	2.77	70.36

Tee Connector Reducer, Redi-flare

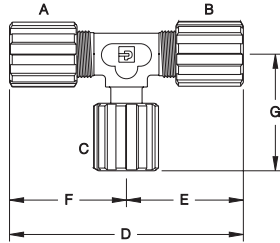

Part Number	A	B	C	Orifice		D		E		F		G	
	Tube Size			inch	mm	inch	mm	inch	mm	inch	mm	inch	mm
FTCR-444RF	1/4	1/4	1/4	0.12	3.05	3.40	86.36	1.70	43.18	1.70	43.18	1.60	40.64
FTCR-466RF	1/4	3/8	3/8	0.12	3.05	3.43	87.12	1.76	44.70	1.68	42.67	1.78	45.21
FTCR-664RF	3/8	3/8	1/4	0.15	3.81	3.52	89.41	1.76	44.70	1.76	44.70	1.70	43.18
FTCR-666RF	3/8	3/8	3/8	0.25	6.35	3.51	89.15	1.76	44.70	1.76	44.70	1.78	45.21
FTCR-884RF	1/2	1/2	1/4	0.15	3.81	3.74	95.00	1.87	47.50	1.87	47.50	1.71	43.43
FTCR-888RF	1/2	1/2	1/2	0.37	9.40	3.71	94.23	1.85	46.99	1.85	46.99	1.83	46.48
FTCR-12124RF	3/4	3/4	1/4	0.15	3.81	4.34	110.24	2.17	55.12	2.17	55.12	1.80	45.72
FTCR-12128RF	3/4	3/4	1/2	0.37	9.40	4.30	109.22	2.15	54.61	2.15	54.61	2.00	50.80
FTCR-121212RF	3/4	3/4	3/4	0.62	15.75	4.24	107.70	2.12	53.85	2.12	53.85	2.24	56.90
FTCR-161612RF	1	1	3/4	0.62	15.75	5.52	140.21	2.76	70.10	2.76	70.10	2.53	64.26
FTCR-161616RF	1	1	1	0.88	22.35	5.52	140.21	2.76	70.10	2.76	70.10	2.99	75.95

Tee Connector Reducer, Redi-flare

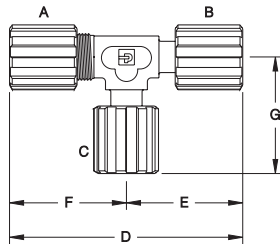

Part Number	A	B	C	Orifice		D		E		F		G	
	Tube Size			inch	mm	inch	mm	inch	mm	inch	mm	inch	mm
FTCR-44RF4RF	1/4	1/4	1/4	0.13	3.30	3.40	86.36	1.70	43.18	1.70	43.18	1.71	43.43
FTCR-66RF4RF	3/8	3/8	1/4	0.15	3.81	3.53	89.66	1.78	45.21	1.76	44.70	1.71	43.43
FTCR-66RF6RF	3/8	3/8	3/8	0.25	6.35	3.53	89.66	1.78	45.21	1.76	44.70	1.78	45.21
FTCR-88RF4RF	1/2	1/2	1/4	0.15	3.81	3.73	94.74	1.86	47.24	1.87	47.50	1.71	43.43
FTCR-88RF8RF	1/2	1/2	1/2	0.38	9.65	3.80	96.52	1.80	45.72	2.00	50.80	2.00	50.80
FTCR-812RF12RF	1/2	3/4	3/4	0.38	9.65	4.44	112.78	2.39	60.71	2.05	52.07	2.40	60.96
FTCR-1212RF8RF	3/4	3/4	1/2	0.37	9.40	4.37	111.00	2.20	55.88	2.07	52.58	2.02	51.31
FTCR-1212RF12RF	3/4	3/4	3/4	0.62	15.75	4.45	113.03	2.28	57.91	2.17	55.12	2.25	57.15
FTCR-1616RF8RF	1	1	1/2	0.38	9.65	5.78	146.81	3.00	76.20	2.78	70.61	2.30	58.42
FTCR-1616RF16RF	1	1	1	0.88	22.35	5.77	146.56	3.00	76.20	2.78	70.61	2.99	75.95

Tee Connector Reducer, Pargrip

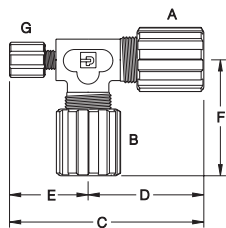

Part Number	A	B	G	Orifice		C		D		E		F	
	Tube Size			Pargrip Size	inch	mm	inch	mm	inch	mm	inch	mm	inch
FTCR-2G66	3/8	3/8	1/8	0.09	3.30	3.40	86.36	1.76	44.70	1.65	41.91	1.76	44.70
FTCR-2G88	1/2	1/2	1/8	0.09	2.29	3.14	79.76	1.87	47.50	1.27	32.26	1.88	47.75

Parflare PFA Tube Fittings

Redi-flare Tubing Union

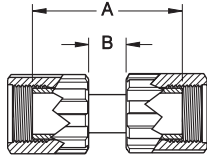

Part Number	Tube Size	A		B	
		inch	mm	inch	mm
RFM-4119	1/4	1.19	30.22	.15	3.81
RFM-4161	1/4	1.61	40.89	.50	12.70
RFM-4344	1/4	3.46	87.88	2.38	60.45
RFM-6133	3/8	1.40	35.56	.15	3.81
RFM-6188	3/8	1.88	47.75	.50	12.70
RFM-8151	1/2	1.52	38.61	.19	4.83
RFM-8201	1/2	2.01	51.05	.50	12.70
RFM-8389	1/2	3.86	98.04	2.31	58.67
RFM-8500	1/2	4.91	124.71	3.44	87.38
RFM-12162	3/4	1.62	41.15	.29	7.37
RFM-12209	3/4	2.09	53.09	.50	12.70
RFM-12489	3/4	4.91	124.71	3.31	84.07
RFM-16223	1	2.23	56.64	.50	12.70
RFM-16380	1	3.91	99.31	2.19	55.63

Tubing Plug, With Nut

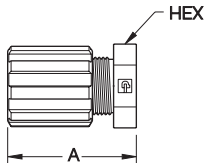

Part Number	Tube Size	A		Hex Size
		inch	mm	
FTPG-4	1/4	1.46	37.08	11/16
FTPG-6	3/8	1.43	36.32	13/16
FTPG-8	1/2	1.62	41.15	15/16
FTPG-12	3/4	1.73	43.94	1 3/16
FTPG-16	1	1.96	49.78	1 7/16

Tubing Plug, Body Only

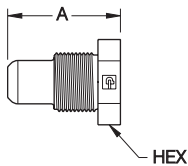

Part Number	Tube Size	A		Hex Size
		inch	mm	
1217-0250	1/4	1.29	32.77	11/16
1217-0251	3/8	1.55	39.37	13/16
1217-0252	1/2	1.44	36.58	15/16
1217-0253	3/4	1.54	39.12	1 3/16
1217-0254	1	1.78	45.21	1 7/16

Fitting Cap



Part Number	Tube Size	A	
		inch	mm
FCAP-4	1/4	0.91	23.11
FCAP-6	3/8	1.02	25.91
FCAP-8	1/2	1.02	25.91
FCAP-12	3/4	1.09	27.69
FCAP-16	1	1.29	32.77
FCAP-20	1 1/4	1.57	39.88

Fitting Nut PVDF

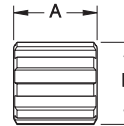

Part Number	Tube Size	A		B	
		inch	mm	inch	mm
1213-0004	1/4	0.99	25.15	0.79	20.07
1213-0006	3/8	1.00	25.40	0.92	23.37
1213-0008	1/2	1.08	27.43	1.05	26.67
1213-0012	3/4	1.25	31.75	1.34	34.04
1213-0016	1	1.50	38.10	1.81	45.97
1213-0020	1 1/4	1.88	47.75	2.31	58.67

Fitting Nut PFA

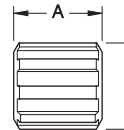

Part Number	Tube Size	A		B	
		inch	mm	inch	mm
1213-0204	1/4	0.97	24.64	0.84	21.34
1213-0206	3/8	0.98	24.89	0.94	23.88
1213-0208	1/2	1.14	28.96	1.10	27.94
1213-0212	3/4	1.23	31.24	1.41	35.81
1213-0216	1	1.46	37.08	1.87	47.50
1213-0220	1 1/4	1.91	48.51	2.40	60.96

Fitting Nut Assembly High Temp.

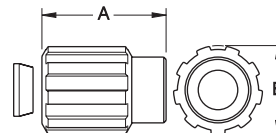

Part Number	Tube Size	A		B	
		inch	mm	inch	mm
1202-0007	1/4	1.20	30.48	0.79	20.07
1202-0008	3/8	1.25	31.75	0.94	23.88
1202-0009	1/2	1.60	40.64	1.15	29.21
1202-0010	3/4	1.70	43.18	1.41	35.81
1202-0011	1	2.00	50.80	1.81	45.97

Pargrip PFA Tube Fittings

Product Overview

The Pargrip Fittings are ideally suited for use in corrosive environments and chemical applications. The fitting design yields a leak-tight connection and requires no special tools to assemble. The connection is achieved by merely inserting the tubing into the fitting assembly and tightening the nut.



Features

PFA body manufactured from virgin High Purity materials.

Ease of assembly.

Leak tight seal.

Numerous configurations available.

Benefits

Less surface particulates resulting in cleaner operation.

Reduced assembly time, and costs.

Less downtime.

Reduced system complexity and cost.

Specifications

Materials of Construction:

Wetted Surfaces - PFA, PTFE
External Surfaces - PVDF, PFA, ETFE

Pressure Ranges:

[See Pressure/Temperature Chart below.](#)

Temperature Ranges:

[See Pressure/Temperature Chart below.](#)

Pargrip PFA fittings are supplied with PFA nuts as standard. Please consult factory for other available configurations, materials, and custom assemblies. [See pages 40-43](#) for assembly tools.

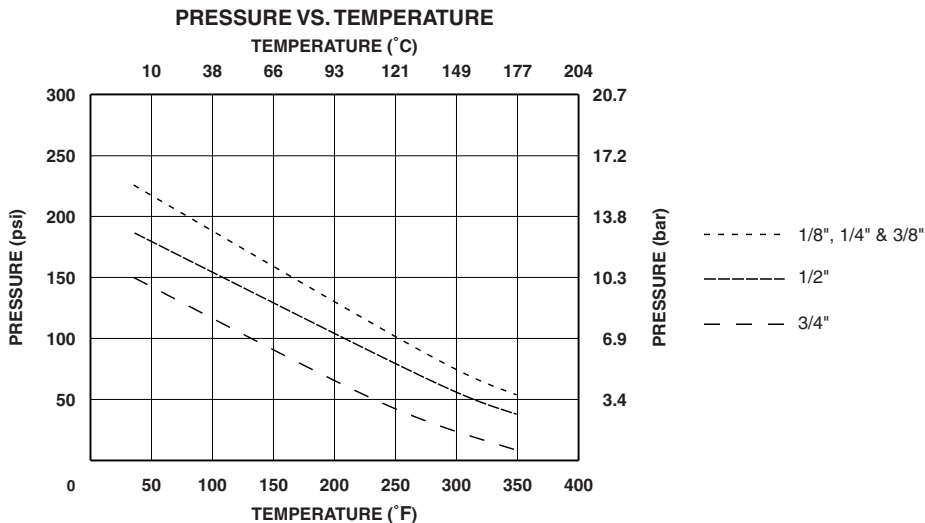

Fitting Size	Tubing Size
2	1/8" O.D. X 1/16" I.D.
4	1/4" O.D. X 5/32" I.D.
6	3/8" O.D. X 1/4" I.D.
8	1/2" O.D. X 3/8" I.D.
12	3/4" O.D. X 5/8" I.D.

Pargrip PFA Tube Fittings

Assembly Procedure

1. Cut tubing evenly using a tube cutter:
TCTR-1 for 1/8" - 1/2"
TCTR-2 for 1/8" - 3/4".
2. Slip small end of the fitting nut over tubing.
3. Slip small end of the gripper onto tubing.
4. Slip large end of the ferrule onto tubing.
5. Slip tubing into the fitting body until bottomed out.
6. Tighten nut finger tight while assuring that tubing remains seated in bottom of fitting body.
7. Tighten nut at least one additional turn.

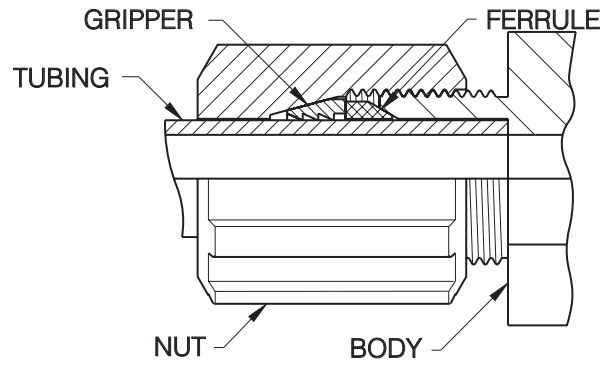

Adaptor Male Straight

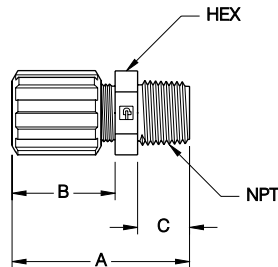

Part Number	Tube Size	NPT Size	Orifice		A		B		C		Hex Size
			inch	mm	inch	mm	inch	mm	inch	mm	
GAMS-22	1/8	1/8	0.09	2.29	1.59	40.39	0.75	19.05	0.55	13.97	1/2
GAMS-24	1/8	1/4	0.09	2.29	1.59	40.39	0.75	19.05	0.55	13.97	5/8
GAMS-42	1/4	1/8	0.18	4.57	2.06	52.32	1.22	30.99	0.55	13.97	5/8
GAMS-44	1/4	1/4	0.18	4.57	2.04	51.82	1.22	30.99	0.55	13.97	5/8
GAMS-46	1/4	3/8	0.18	4.57	2.09	53.09	1.26	32.00	0.55	13.97	13/16
GAMS-48	1/4	1/2	0.18	4.57	2.15	54.61	1.20	30.48	0.66	16.76	13/16
GAMS-412	1/4	3/4	0.18	4.57	2.08	52.83	1.13	28.70	0.67	17.02	1 3/16
GAMS-62	3/8	1/8	0.25	6.35	2.00	50.80	1.16	29.46	0.55	13.97	13/16
GAMS-64	3/8	1/4	0.25	6.35	1.93	49.02	1.11	28.19	0.55	13.97	13/16
GAMS-66	3/8	3/8	0.25	6.35	1.96	49.78	1.13	28.70	0.55	13.97	13/16
GAMS-68	3/8	1/2	0.25	6.35	2.06	52.32	1.11	28.19	0.65	16.51	15/16
GAMS-84	1/2	1/4	0.29	7.37	2.06	52.32	1.23	31.24	0.55	13.97	15/16
GAMS-86	1/2	3/8	0.38	9.65	2.07	52.58	1.23	31.24	0.55	13.97	15/16
GAMS-88	1/2	1/2	0.38	9.65	2.18	55.37	1.23	31.24	0.66	16.76	15/16
GAMS-812	1/2	3/4	0.38	9.65	2.15	54.61	1.23	31.24	0.65	16.51	1 3/16
GAMS-128	3/4	1/2	0.54	13.72	2.39	60.71	1.44	36.58	0.67	17.02	1 3/16
GAMS-1212	3/4	3/4	0.63	15.88	2.38	60.45	1.44	36.58	0.66	16.76	1 3/16

Adaptor Male Straight, Panel Mount

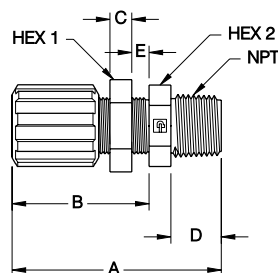

Part Number	Tube Size	NPT Size	Orifice		A		B		C		D		E (max.)		Hole Size		Hex 1 Size	Hex 2 Size
			inch	mm	inch	mm	inch	mm	inch	mm	inch	mm	inch	mm	inch	mm		
GAMS-44-P	1/4	1/4	0.18	4.57	2.49	63.25	1.69	42.93	0.29	7.37	0.55	13.97	0.25	6.35	0.50	12.70	11/16	11/16
GAMS-66-P	3/8	3/8	0.25	6.35	2.40	60.96	1.56	39.62	0.29	7.37	0.55	13.97	0.25	6.35	0.63	16.00	15/16	13/16
GAMS-88-P	1/2	1/2	0.38	9.65	2.64	67.06	1.69	42.93	0.29	7.37	0.66	16.76	0.25	6.35	0.75	19.05	1 1/16	15/16
GAMS-1212-P	3/4	3/4	0.63	15.88	3.08	78.23	2.07	52.58	0.29	7.37	0.65	16.51	0.5	12.70	1.00	25.40	1 5/16	1 3/16

Adaptor Female Straight

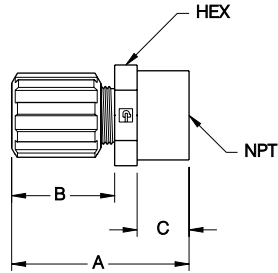

Part Number	Tube Size	NPT Size	Orifice		A		B		C		Hex Size
			inch	mm	inch	mm	inch	mm	inch	mm	
GAFS-22	1/8	1/8	0.09	2.29	1.60	40.64	0.75	19.05	0.56	14.22	5/8
GAFS-24	1/8	1/4	0.09	2.29	1.61	40.89	0.75	19.05	0.57	14.48	3/4
GAFS-42	1/4	1/8	0.18	4.57	1.98	50.29	1.13	28.70	0.56	14.22	5/8
GAFS-44	1/4	1/4	0.18	4.57	1.98	50.29	1.13	28.70	0.56	14.22	3/4
GAFS-46	1/4	3/8	0.18	4.57	1.97	50.04	1.13	28.70	0.55	13.97	15/16
GAFS-48	1/4	1/2	0.18	4.57	2.08	52.83	1.13	28.70	0.66	16.76	1 3/16
GAFS-64	3/8	1/4	0.25	6.35	1.96	49.78	1.13	28.70	0.56	14.22	3/4
GAFS-66	3/8	3/8	0.25	6.35	1.97	50.04	1.13	28.70	0.55	13.97	15/16
GAFS-68	3/8	1/2	0.25	6.35	2.06	52.32	1.11	28.19	0.67	17.02	1
GAFS-84	1/2	1/4	0.31	7.87	2.04	51.82	1.21	30.73	0.56	14.22	3/4
GAFS-86	1/2	3/8	0.38	9.65	2.03	51.56	1.21	30.73	0.55	13.97	15/16
GAFS-88	1/2	1/2	0.37	9.40	2.16	54.86	1.22	30.99	0.66	16.76	1 1/16
GAFS-812	1/2	3/4	0.38	9.65	2.15	54.61	1.23	31.24	0.67	17.02	1 3/16
GAFS-816	1/2	1	0.38	9.65	2.35	59.69	1.23	31.24	0.85	21.59	1 5/8
GAFS-1212	3/4	3/4	0.62	15.75	2.39	60.71	1.43	36.32	0.67	17.02	1 3/16

Straight Connector

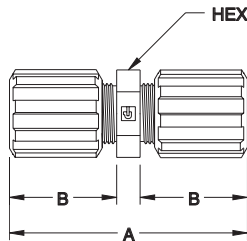

Part Number	Tube Size	Orifice		A		B		Hex Size
		inch	mm	inch	mm	inch	mm	
GSC-2	1/8	0.09	2.29	1.79	45.47	0.75	19.05	1/2
GSC-4	1/4	0.18	4.57	2.55	64.77	1.13	28.70	5/8
GSC-6	3/8	0.25	6.35	2.53	64.26	1.12	28.45	13/16
GSC-8	1/2	0.38	9.65	2.75	69.85	1.23	31.24	15/16
GSC-12	3/4	0.63	15.88	3.16	80.26	1.43	36.32	1 3/16

Straight Connector, Panel Mount

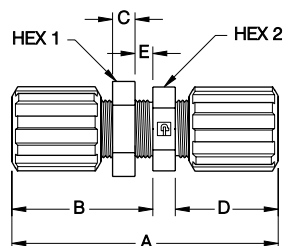

Part Number	Tube Size	Orifice		A		B		C		D		E (max.)		Hole Size		Hex 1 Size	Hex 2 Size
		inch	mm	inch	mm	inch	mm	inch	mm	inch	mm	inch	mm	inch	mm		
GSC-2-P	1/8	0.09	2.29	2.28	57.91	1.24	31.50	0.19	4.83	0.75	19.05	0.25	6.35	0.32	8.13	1/2	1/2
GSC-4-P	1/4	0.18	4.57	3.11	78.99	1.67	42.42	0.29	7.37	1.15	29.21	0.25	6.35	0.50	12.70	11/16	11/16
GSC-6-P	3/8	0.25	6.35	2.95	74.93	1.54	39.12	0.29	7.37	1.12	28.45	0.25	6.35	0.63	16.00	15/16	13/16
GSC-8-P	1/2	0.38	9.65	3.21	81.53	1.72	43.69	0.29	7.37	1.21	30.73	0.25	6.35	0.75	19.05	1 1/16	15/16
GSC-12-P	3/4	0.63	16.00	3.82	97.03	2.08	52.83	0.29	7.37	1.45	36.83	0.25	6.35	1.00	25.40	1 5/16	1 3/16

Pargrip PFA Tube Fittings

Straight Connector Panel Mount, Extended

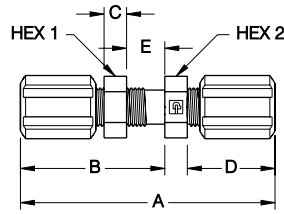

Part Number	Tube Size	Orifice		A		B		C		D		E (max.)		Hole Size		Hex 1 Size	Hex 2 Size
		inch	mm	inch	mm	inch	mm	inch	mm	inch	mm	inch	mm	inch	mm		
GSC-4-PX	1/4	0.18	4.57	3.28	83.31	1.86	47.24	0.29	7.37	1.13	28.70	0.50	12.70	0.50	12.70	11/16	11/16

Straight Connector Reducer

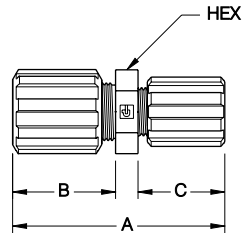

Part Number	Tube Size	Orifice		A		B		C		Hex Size
		inch	mm	inch	mm	inch	mm	inch	mm	
GSCR-42	1/4 X 1/8	0.09	2.29	2.17	55.12	1.13	28.70	0.75	19.05	5/8
GSCR-64	3/8 X 1/4	0.18	4.57	2.54	64.52	1.12	28.45	1.13	28.70	11/16
GSCR-82	1/2 X 1/8	0.09	2.29	2.37	60.20	1.33	33.78	0.75	19.05	15/16
GSCR-84	1/2 X 1/4	0.18	4.57	2.67	67.82	1.23	31.24	1.15	29.21	15/16
GSCR-86	1/2 X 3/8	0.25	6.35	2.55	64.77	1.19	30.23	1.07	27.18	15/16
GSCR-128	3/4 X 1/2	0.37	9.40	2.92	74.17	1.42	36.07	1.21	30.73	1 3/16

Adaptor Male Elbow

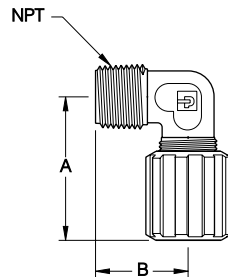

Part Number	Tube Size	NPT Size	Orifice		A		B	
			inch	mm	inch	mm	inch	mm
GAME-24	1/8	1/4	0.09	2.29	1.27	32.26	1.07	27.18
GAME-42	1/4	1/8	0.18	4.57	1.66	42.16	1.08	27.43
GAME-44	1/4	1/4	0.18	4.57	1.64	41.66	1.07	27.18
GAME-46	1/4	3/8	0.18	4.57	1.71	43.43	1.08	27.43
GAME-48	1/4	1/2	0.18	4.57	1.66	42.16	1.19	30.23
GAME-62	3/8	1/8	0.20	5.08	1.63	41.40	1.07	27.18
GAME-64	3/8	1/4	0.25	6.35	1.62	41.15	1.07	27.18
GAME-66	3/8	3/8	0.25	6.35	1.63	41.40	1.07	27.18
GAME-68	3/8	1/2	0.25	6.35	1.63	41.40	1.18	29.97
GAME-84	1/2	1/4	0.29	7.37	1.74	44.20	1.08	27.43
GAME-86	1/2	3/8	0.38	9.65	1.71	43.43	1.08	27.43
GAME-88	1/2	1/2	0.38	9.65	1.74	44.20	1.18	29.97
GAME-812	1/2	3/4	0.38	9.65	1.89	48.01	1.36	34.54
GAME-128	3/4	1/2	0.54	13.72	2.15	54.61	1.37	34.80
GAME-1212	3/4	3/4	0.63	16.00	2.13	54.10	1.35	34.29

Adaptor Female Elbow

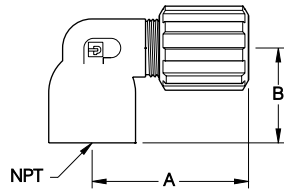

Part Number	Tube Size	NPT Size	Orifice		A		B	
			inch	mm	inch	mm	inch	mm
GAFE-22	1/8	1/8	0.09	2.29	1.45	36.83	0.83	21.08
GAFE-24	1/8	1/4	0.09	2.29	1.42	36.07	0.97	24.64
GAFE-44	1/4	1/4	0.16	4.06	1.82	46.23	0.97	24.64
GAFE-64	3/8	1/4	0.25	6.35	1.81	45.97	0.94	23.88
GAFE-66	3/8	3/8	0.25	6.35	1.81	45.97	1.00	25.40
GAFE-68	3/8	1/2	0.25	6.35	1.77	44.96	1.23	31.24
GAFE-88	1/2	1/2	0.38	9.55	1.93	49.02	1.23	31.24

Elbow Connector

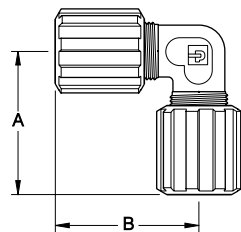

Part Number	Tube Size	Orifice		A		B	
		inch	mm	inch	mm	inch	mm
GEC-2	1/8	0.09	2.29	1.27	32.26	1.27	32.26
GEC-4	1/4	0.18	4.57	1.66	42.16	1.66	42.16
GEC-6	3/8	0.25	6.22	1.61	40.89	1.61	40.89
GEC-8	1/2	0.37	9.47	1.74	44.20	1.74	44.20
GEC-12	3/4	0.62	15.75	2.11	53.59	2.11	53.59

Elbow Connector, Redi-flare

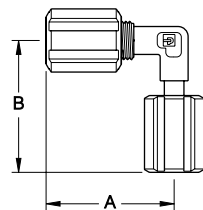

Part Number	Tube Size	Orifice		A		B	
		inch	mm	inch	mm	inch	mm
GEC-4RF4	1/4 X 1/4	0.13	3.30	1.65	41.91	1.70	43.18

Elbow Connector, Panel Mount

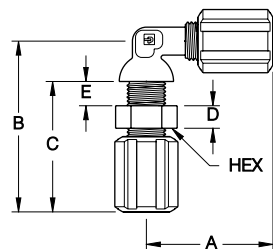

Part Number	Tube Size	Orifice		A		B		C		D		E (max.)		Hole Size		Hex Size
		inch	mm	inch	mm	inch	mm	inch	mm	inch	mm	inch	mm	inch	mm	
GEC-4-P	1/4	0.18	4.57	1.63	41.40	2.20	55.88	1.68	42.67	0.29	7.37	0.25	6.35	0.50	12.70	11/16

Pargrip PFA Tube Fittings

Elbow Connector Reducer

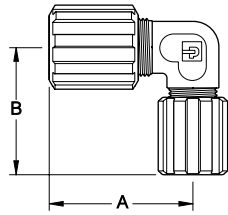

Part Number	Tube Size	Orifice		A		B	
		inch	mm	inch	mm	inch	mm
GECR-42	1/4 X 1/8	0.09	2.29	1.64	41.66	1.26	32.00
GECR-64	3/8 X 1/4	0.18	4.50	1.65	41.91	1.61	40.89
GECR-84	1/2 X 1/4	0.17	4.42	1.67	42.42	1.73	43.94
GECR-86	1/2 X 3/8	0.25	6.22	1.70	43.18	1.59	40.39

Elbow Connector Reducer, Redi-flare

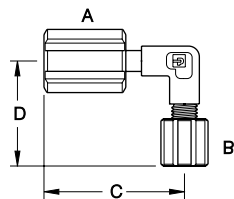

Part Number	A	B	Orifice		C		D	
	Tube Size Redi-flare X Pargrip	inch	mm	inch	mm	inch	mm	
GECR-4RF2	1/4	1/8	0.09	2.29	1.70	43.18	1.27	32.26

Adaptor Male Tee

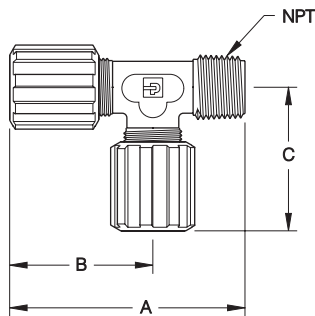

Part Number	Tube Size	NPT Size	Orifice		A		B		C	
			inch	mm	inch	mm	inch	mm	inch	mm
GAMT-222	1/8 X 1/8	1/8	0.09	2.29	2.35	59.69	1.27	32.26	1.26	32.00
GAMT-242	1/8 X 1/8	1/4	0.09	2.29	2.35	59.69	1.27	32.26	1.26	32.00
GAMT-424	1/4 X 1/4	1/8	0.18	4.57	2.74	69.60	1.66	42.16	1.66	42.16
GAMT-444	1/4 X 1/4	1/4	0.18	4.57	2.74	69.60	1.66	42.16	1.65	41.91
GAMT-646	3/8 X 3/8	1/4	0.25	6.35	2.73	69.34	1.65	41.91	1.65	41.91
GAMT-848	1/2 X 1/2	1/4	0.29	7.37	2.81	71.37	1.74	44.20	1.74	44.20
GAMT-888	1/2 X 1/2	1/2	0.37	9.40	2.93	74.42	1.76	44.70	1.73	43.94

Branch Male Tee

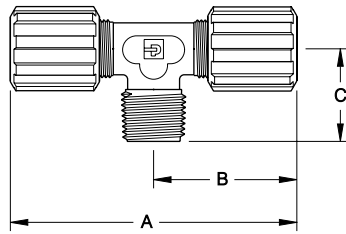

Part Number	Tube Size	NPT Size	Orifice		A		B		C	
			inch	mm	inch	mm	inch	mm	inch	mm
GBMT-222	1/8 X 1/8	1/8	0.09	2.29	2.55	64.77	1.28	32.51	1.07	27.18
GBMT-224	1/8 X 1/8	1/4	0.09	2.29	2.55	64.77	1.28	32.51	1.07	27.18
GBMT-442	1/4 X 1/4	1/8	0.18	4.57	3.39	86.11	1.69	42.93	1.08	27.43
GBMT-444	1/4 X 1/4	1/4	0.18	4.57	3.39	86.11	1.69	42.93	1.08	27.43
GBMT-662	3/8 X 3/8	1/8	0.25	6.35	3.26	82.80	1.63	41.40	1.07	27.18
GBMT-664	3/8 X 3/8	1/4	0.25	6.35	3.22	81.79	1.61	40.89	1.07	27.18
GBMT-666	3/8 X 3/8	3/8	0.25	6.35	3.26	82.80	1.63	41.40	1.07	27.18
GBMT-668	3/8 X 3/8	1/2	0.25	6.35	3.26	82.80	1.63	41.40	1.18	29.97
GBMT-884	1/2 X 1/2	1/4	0.29	7.37	3.47	88.14	1.74	44.20	0.88	22.35
GBMT-886	1/2 X 1/2	3/8	0.38	9.65	3.49	88.65	1.74	44.20	1.08	27.43
GBMT-888	1/2 X 1/2	1/2	0.37	9.47	3.48	88.39	1.74	44.20	1.17	29.72

Tee Connector

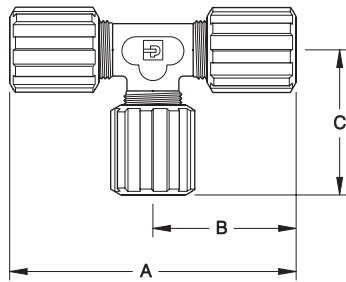

Part Number	Tube Size	Orifice		A		B		C	
		inch	mm	inch	mm	inch	mm	inch	mm
GTC-2	1/8	0.09	2.29	2.55	64.77	1.28	32.51	1.27	32.26
GTC-4	1/4	0.17	4.32	3.30	83.82	1.65	41.91	1.65	41.91
GTC-6	3/8	0.25	6.35	3.27	83.06	1.63	41.40	1.63	41.40
GTC-8	1/2	0.37	9.40	3.51	89.15	1.75	44.45	1.74	44.20
GTC-12	3/4	0.63	16.00	4.28	108.71	2.14	54.36	2.14	54.36

Tee Connector Reducer

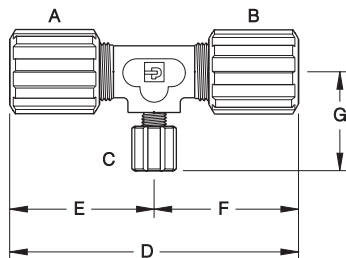

Part Number	A	B	C	Orifice		D		E		F		G	
	Tube Size			inch	mm	inch	mm	inch	mm	inch	mm	inch	mm
GTCR-224	1/8	1/8	1/4	0.09	2.29	2.55	64.77	1.28	32.51	1.28	32.51	1.65	41.91
GTCR-442	1/4	1/4	1/8	0.09	2.29	3.31	84.07	1.66	42.16	1.66	42.16	1.27	32.26
GTCR-466	1/4	3/8	3/8	0.18	4.45	3.30	83.82	1.66	41.91	1.65	41.91	1.65	41.91
GTCR-664	3/8	3/8	1/4	0.18	4.45	3.22	81.79	1.61	40.89	1.61	40.89	1.69	42.93
GTCR-882	1/2	1/2	1/8	0.09	2.29	3.70	93.98	1.85	46.99	1.85	46.99	1.28	32.51

Pargrip PFA Tube Fittings

Tubing Plug

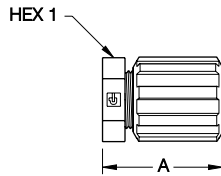

Part Number	Tube Size	A		Hex Size
		inch	mm	
GTPG-2	1/8	1.04	26.42	1/2
GTPG-4	1/4	1.42	36.07	11/16
GTPG-6	3/8	1.41	35.81	13/16
GTPG-8	1/2	1.56	39.62	3/4
GTPG-12	3/4	1.73	43.94	1 3/16

Gripper



Part Number	Tube Size
1207-0023	1/8
1207-0001	1/4
1207-0002	3/8
1207-0003	1/2
1207-0004	3/4

Fitting Cap

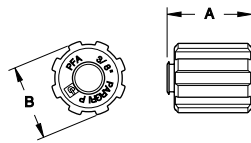

Part Number	Tube Size	A		B	
		inch	mm	inch	mm
GCAP-4	1/4	1.13	28.70	0.84	21.34
GCAP-6	3/8	1.09	27.69	0.97	24.64

Ferrule



Part Number	Tube Size
1022-0002	1/8
1022-0004	1/4
1022-0006	3/8
1022-0008	1/2
1022-0012	3/4

Fitting Nut PFA

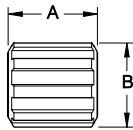

Part Number	Tube Size	A		B	
		inch	mm	inch	mm
1213-0302	1/8	0.57	14.48	0.57	14.48
1213-0304	1/4	0.97	24.64	0.84	21.34
1213-0306	3/8	0.98	24.89	0.94	23.88
1213-0308	1/2	1.13	28.70	1.10	27.94
1213-0312	3/4	1.23	31.24	1.41	35.81

Fitting Nut Assembly

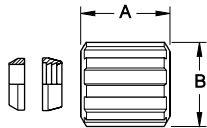

Part Number	Tube Size	A		B	
		inch	mm	inch	mm
1202-0012	1/8	0.56	14.22	0.56	14.22
1202-0001	1/4	0.97	24.64	0.84	21.34
1202-0002	3/8	0.98	24.89	0.94	23.88
1202-0003	1/2	1.13	28.70	1.10	27.94
1202-0004	3/4	1.23	31.24	1.41	35.81

Product Overview

The Parbond Fittings are ideally suited for any ultra-pure or corrosive chemical application. The fitting design yields a leak-tight, permanent connection that is ideal for high flow, minimal pressure drop applications. The connection is achieved by fusion welding the two ends together.



Features

PFA body manufactured from virgin High Purity materials.

High integrity fused weld connections.

Numerous configurations including reducers.

Benefits

Less surface particulates resulting in cleaner operation.

Less down time, fewer leaks.

Reduced system complexity and cost.

Specifications

Materials of Construction:

Wetted Surfaces - PFA
External Surfaces - PFA, PVDF

Pressure Ranges:

[See Pressure/Temperature Chart below.](#)

Temperature Ranges:

[See Pressure/Temperature Chart below.](#)

Parbond PFA fittings with Parflare ends are supplied with PVDF nuts as standard. For PFA nuts add -T to model number. Please consult factory for other available configurations and custom assemblies.

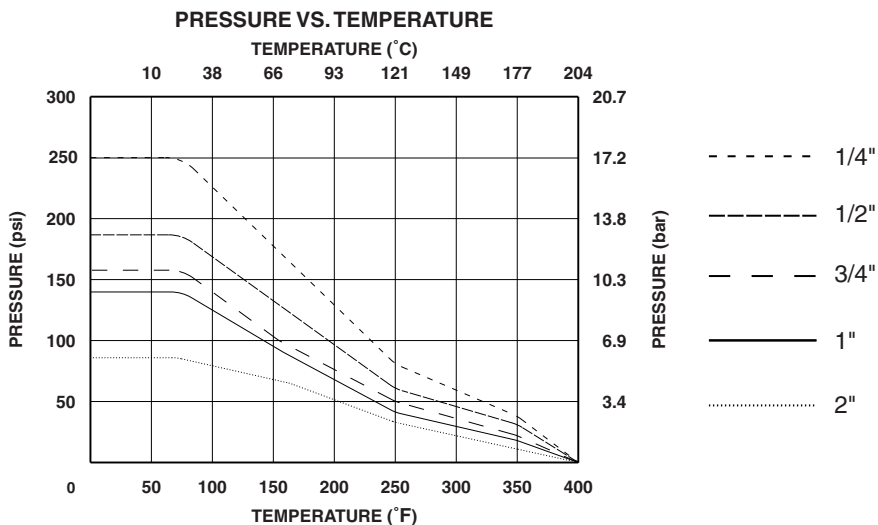

Parbond PFA Fusible Pipe Fittings

Bonding of Parbond fittings is accomplished by heating the two surfaces with a non-contact heat source to a molten state, pressing the two surfaces together, and allowing sufficient time to cool. Proper technique results in a permanent connection being made without introducing foreign matter or contamination. Below are examples of a correct and incorrect weld joints.

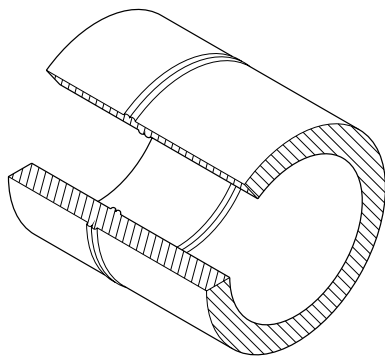

Correct Weld

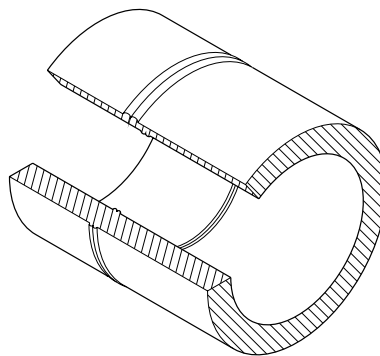

Condition- Weld bead uneven.
Causes- Incomplete facing operation.
Uneven heating.

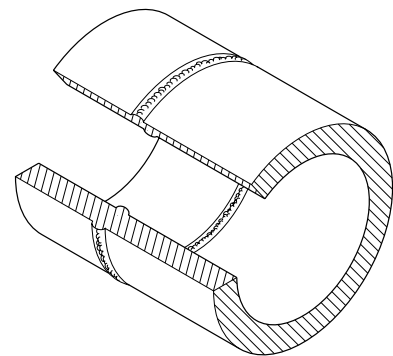

Condition- Bubbles in weld joint.
Causes- Overheating of material prior to joining.

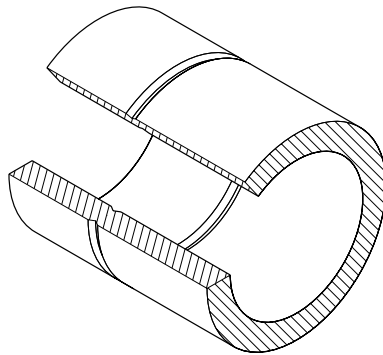

Condition- Lack of raised bead.
Causes- Insufficient joining force.
Joint weld distance too far apart.

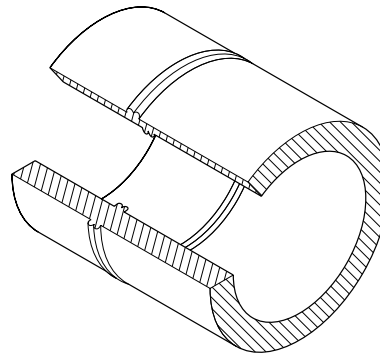

Condition- Weld bead too large.
Causes- Excessive joining force.
Joint weld distance too close.

Adaptor Male Straight

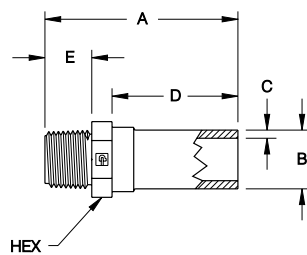

Part Number	MNPT Size	Parbond Size	Orifice		A		B		C		D		E		Hex Size
			inch	mm	inch	mm	inch	mm	inch	mm	inch	mm	inch	mm	
BA-4MP4	1/4	1/4	0.29	7.37	1.41	35.81	0.54	13.72	0.08	2.03	0.56	14.22	0.55	13.97	11/16
BA-8MP8	1/2	1/2	0.52	13.21	2.75	69.85	0.84	21.34	0.11	2.79	1.80	45.72	0.66	16.76	15/16
BA-12MP12	3/4	3/4	0.65	16.51	2.77	70.36	1.05	26.67	0.12	3.05	1.80	45.72	0.66	16.76	1 3/16
BA-12MP8	3/4	1/2	0.65	16.51	2.75	69.85	0.84	21.34	0.11	2.79	1.80	45.72	0.66	16.76	1 3/16
BA-16MP12	1	3/4	0.85	21.59	2.62	66.55	1.05	26.67	0.12	3.05	1.49	44.96	0.85	21.59	1 7/16
BA-16MP16	1	1	0.94	23.88	2.92	74.17	1.32	33.40	0.13	3.30	1.78	45.21	0.85	21.59	1 7/16

Parbond PFA Fusible Pipe Fittings

Adaptor Female Straight

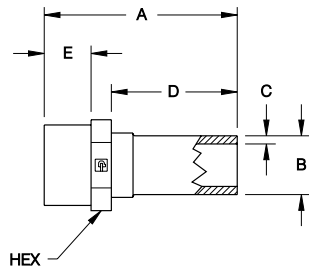

Part Number	FNPT Size	Parbond Size	Orifice		A		B		C		D		E		Hex Size
			inch	mm	inch	mm	inch	mm	inch	mm	inch	mm	inch	mm	
BA-4FP4	1/4	1/4	0.38	9.65	1.41	35.81	0.54	13.74	0.08	2.01	0.56	14.22	0.56	14.22	3/4
BA-6FP4	3/8	1/4	0.38	9.65	1.41	35.81	0.54	13.72	0.08	2.03	0.56	14.22	0.62	15.75	15/16
BA-8FP8	1/2	1/2	0.57	14.48	2.75	69.85	0.84	21.41	0.10	2.60	1.68	42.67	0.67	17.02	1 1/8
BA-12FP12	3/4	3/4	0.85	21.59	2.45	62.10	1.05	26.67	0.11	2.83	1.48	37.59	.68	17.27	1 7/16
BA-16FP16	1	1	0.97	24.64	2.94	74.68	1.32	33.40	0.13	3.24	1.78	45.21	0.96	24.38	1 5/8

Adaptor, Parflare

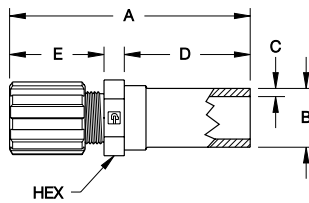

Part Number	Parflare Size	Parbond Size	Orifice		A		B		C		D		E		Hex Size
			inch	mm	inch	mm	inch	mm	inch	mm	inch	mm	inch	mm	
BA-4F4	1/4	1/4	0.13	3.30	2.05	52.07	0.56	14.22	0.09	2.16	0.56	14.22	1.16	29.46	11/16
BA-4F8	1/4	1/2	0.13	3.30	3.28	83.31	0.84	21.44	0.10	2.54	1.68	42.67	1.16	29.46	15/16
BA-4F12	1/4	3/4	0.13	3.30	3.28	83.31	1.05	26.67	0.11	2.79	1.77	44.96	1.16	29.46	1 3/16
BA-6F4	3/8	1/4	0.25	6.35	1.98	50.29	0.54	13.79	0.08	1.91	0.56	14.22	1.24	31.50	13/16
BA-6F8	3/8	1/2	0.25	6.35	3.26	82.80	0.84	21.41	0.10	2.54	1.80	45.72	1.24	31.50	15/16
BA-6F12	3/8	3/4	0.25	6.35	3.30	83.82	1.06	26.80	0.12	2.92	1.77	44.96	1.24	31.50	1 3/16
BA-8F4	1/2	1/4	0.38	9.65	2.20	55.88	0.55	13.97	0.10	2.41	0.56	14.22	1.34	34.04	15/16
BA-8F8	1/2	1/2	0.38	9.65	3.40	86.36	0.84	21.41	0.10	2.64	1.80	45.72	1.34	34.04	15/16
BA-8F12	1/2	3/4	0.38	9.65	3.34	84.84	1.06	26.80	0.11	2.79	1.77	44.96	1.34	34.04	1 3/16
BA-8F16	1/2	1	0.38	9.65	3.36	85.34	1.32	33.53	0.13	3.30	1.78	45.21	1.34	34.04	1 7/16
BA-12F8	3/4	1/2	0.63	16.00	3.55	90.17	0.85	21.49	0.11	2.67	1.80	45.72	1.46	37.08	1 3/16
BA-12F12	3/4	3/4	0.63	16.00	3.55	90.17	1.05	26.67	0.11	2.79	1.77	44.96	1.46	37.08	1 3/16
BA-12F16	3/4	1	0.63	16.00	3.55	90.17	1.32	33.40	0.14	3.43	1.78	45.21	1.46	37.08	1 7/16
BA-16F12	1	3/4	0.88	22.35	3.79	96.27	1.06	26.80	0.11	2.79	1.77	44.96	1.76	44.70	1 7/16
BA-16F16	1	1	0.88	22.35	3.79	96.27	1.32	33.40	0.13	3.24	1.77	44.96	1.76	44.70	1 7/16

Adaptor, Redi-flare

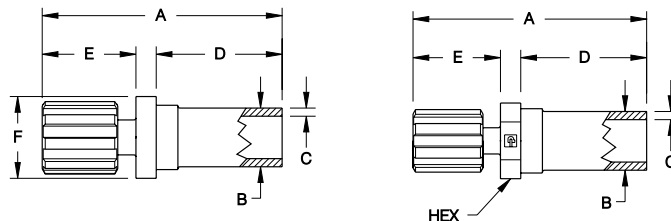

Part Number	Redi-flare Size	Parbond Size	Orifice		A		B		C		D		E		F		Hex Size
			inch	mm	inch	mm	inch	mm	inch	mm	inch	mm	inch	mm	inch	mm	
BA-4RF4	1/4	1/4	0.13	3.30	2.04	51.82	0.55	13.89	0.08	2.03	0.56	14.22	1.16	29.46	-	-	11/16
BA-6RF4	3/8	1/4	0.25	6.35	2.10	53.34	0.55	13.89	0.09	2.29	0.56	14.22	1.24	31.50	-	-	11/16
BA-8RF8	1/2	1/2	0.38	9.65	3.42	86.87	0.84	21.39	0.10	2.59	1.80	45.72	1.37	34.80	1.17	29.72	-
BA-8RF12	1/2	3/4	0.38	9.65	3.11	78.99	1.05	26.67	0.11	2.87	1.77	44.96	1.37	34.80	1.41	35.81	-
BA-12RF8	3/4	1/2	0.63	16.00	3.74	95.00	0.84	21.34	0.10	2.54	1.80	45.72	1.46	37.08	1.17	29.72	-
BA-12RF12	3/4	3/4	0.63	16.00	3.35	85.09	1.05	26.67	0.11	2.79	1.48	37.59	1.46	37.08	1.41	35.81	-
BA-12RF16	3/4	1	0.63	16.00	3.61	91.69	1.31	33.27	0.13	3.30	1.78	45.21	1.46	37.08	1.42	36.07	-
BA-16RF12	1	3/4	0.88	22.35	3.96	100.6	1.05	26.67	0.11	2.78	1.77	44.96	1.76	44.70	1.39	35.31	-
BA-16RF16	1	1	0.88	22.35	3.85	97.79	1.31	33.27	0.13	3.18	1.78	45.21	1.76	44.70	1.41	35.81	-

Parbond PFA Fusible Pipe Fittings

Adaptor, Parflare, Panel Mount

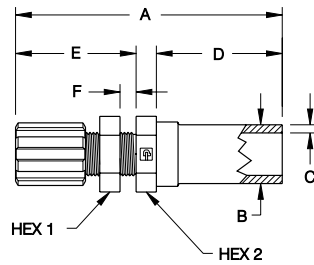

Part Number	Redi-flare Size	Parbond Size	Orifice		A		B		C		D		E		F		Hole Size		Hex 1 Size	Hex 2 Size
			inch	mm	inch	mm	inch	mm	inch	mm	inch	mm	inch	mm	inch	mm	inch	mm		
BA-4F4-P	1/4	1/4	0.13	3.30	2.50	63.50	0.54	13.72	0.08	1.91	0.56	14.22	1.65	41.91	0.25	6.35	0.50	12.70	11/16	11/16
BA-6F4-P	3/8	1/4	0.25	6.35	2.39	60.71	0.54	13.72	0.08	1.91	0.56	14.22	1.62	41.15	0.25	6.35	0.63	16.00	15/16	13/16
BA-8F4-P	1/2	1/4	0.38	9.65	2.56	65.02	0.55	13.87	0.08	2.03	0.56	14.22	1.74	44.20	0.25	6.35	0.75	19.05	1 1/16	15/16
BA-12F8-P	3/4	1/2	0.63	16.00	4.22	107.2	0.85	21.46	0.11	2.67	1.80	45.72	2.13	54.10	0.50	12.70	1.00	25.40	1 5/16	1 3/16

Adaptor, Flange, Flat Face

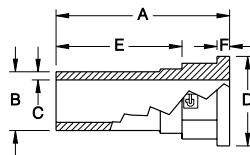

Part Number	Parbond Size	A		B		C		D		E		F	
		inch	mm	inch	mm	inch	mm	inch	mm	inch	mm	inch	mm
BA-8FL-0	1/2	2.49	63.25	0.84	21.34	0.12	2.96	1.29	32.77	1.49	37.85	0.22	5.59
BA-12FL-0	3/4	2.48	62.99	1.05	26.67	0.11	2.87	1.46	37.08	1.49	37.85	0.22	5.59

Adaptor, Flange, Flat Face

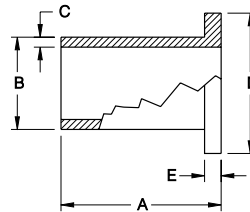

Part Number	Parbond Size	A		B		C		D		E	
		inch	mm	inch	mm	inch	mm	inch	mm	inch	mm
BA-16FL-0	1	2.28	57.91	1.32	33.53	0.14	3.56	2.00	50.80	0.24	6.10
BA-32FL-0	2	2.37	60.20	2.40	60.96	0.17	4.41	3.47	88.14	0.25	6.35

Adaptor, Flange, O-Ring Face

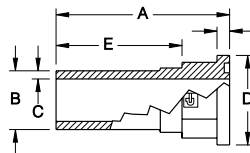

Part Number	Parbond Size	A		B		C		D		E		F	
		inch	mm	inch	mm	inch	mm	inch	mm	inch	mm	inch	mm
BA-8FL-1	1/2	2.48	62.99	0.85	21.49	0.11	2.68	1.28	32.51	1.49	37.85	0.18	4.57

O-Ring, PFA Encapsulated Viton

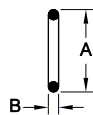

Part Number	Parbond Size	A		B	
		inch	mm	inch	mm
2000-0118EV	1/2	1.068	27.13	.103	2.62

Parbond PFA Fusible Pipe Fittings

Reducer

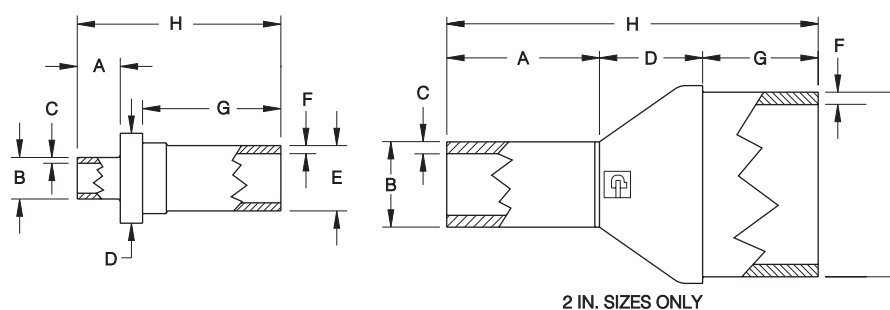

Part Number	Parbond Size	A		B		C		D		E		F		G		H	
		inch	mm	inch	mm	inch	mm	inch	mm	inch	mm	inch	mm	inch	mm	inch	mm
BR-84	1/2 X 1/4	0.56	14.22	0.54	13.72	0.08	1.91	0.93	23.62	0.85	21.59	0.11	2.79	1.80	45.72	2.64	67.06
BR-128	3/4 X 1/2	1.49	38.10	0.84	21.34	0.10	2.54	1.16	29.46	1.05	26.67	0.11	2.67	1.49	37.85	3.58	90.93
BR-168	1 X 1/2	1.49	37.85	0.84	21.41	0.10	2.60	1.41	35.81	1.32	33.40	0.13	3.24	1.78	45.21	3.57	90.68
BR-1612	1 X 3/4	1.49	37.59	1.05	26.67	0.11	2.79	1.41	35.81	1.32	33.53	0.14	3.43	1.78	45.21	3.57	90.68
BR-328	2 X 1/2	1.50	38.10	0.84	21.34	0.11	2.79	2.55	64.77	2.38	60.45	0.16	4.06	1.50	38.10	4.38	111.3
BR-3212	2 X 3/4	1.50	37.59	1.05	26.67	0.12	3.05	2.55	64.77	2.39	60.71	0.16	4.06	1.50	38.10	4.37	111.0
BR-3216	2 X 1	1.50	37.59	1.32	33.53	0.14	3.56	2.54	64.52	2.38	60.45	0.16	4.06	1.50	38.10	4.38	111.3

Union

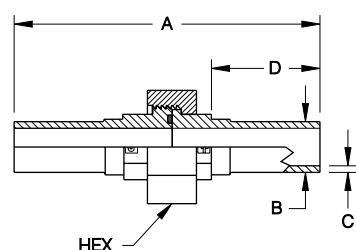

Part Number	Parbond Size	A		B		C		D		Hex Size
		inch	mm	inch	mm	inch	mm	inch	mm	
BU-4	1/4	2.49	63.25	0.54	13.79	0.08	2.01	0.76	19.30	1 1/4
BU-8	1/2	5.07	128.78	0.85	21.46	0.11	2.69	1.80	45.72	1 5/8
BU-12	3/4	5.07	128.78	1.05	26.75	0.11	2.86	1.80	45.72	1 7/8
BU-16	1	5.62	142.75	1.32	33.53	0.13	3.31	1.50	38.10	2 7/8

Cap

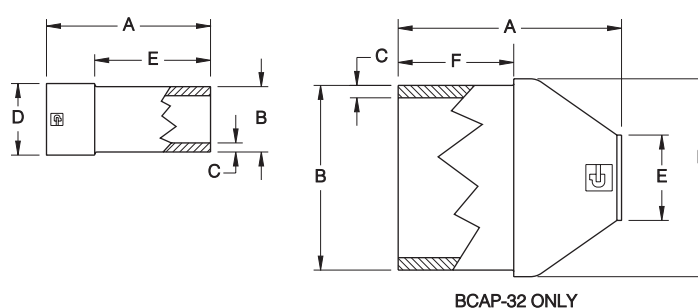

Part Number	Parbond Size	A		B		C		D		E		F	
		inch	mm	inch	mm	inch	mm	inch	mm	inch	mm	inch	mm
BCAP-4	1/4	0.84	21.34	0.54	13.82	0.08	2.02	0.62	15.75	0.55	13.97	N/A	N/A
BCAP-8	1/2	2.09	53.09	0.84	21.41	0.11	2.67	0.91	23.11	1.49	37.85	N/A	N/A
BCAP-12	3/4	2.08	52.83	1.05	26.67	0.11	2.79	1.16	29.46	1.49	37.85	N/A	N/A
BCAP-16	1	2.06	52.32	1.32	33.40	0.13	3.24	1.42	36.07	1.48	37.59	N/A	N/A
BCAP-32	2	2.88	73.15	2.38	60.45	0.16	4.06	2.55	64.77	1.10	27.94	1.49	37.85

Parbond PFA Fusible Pipe Fittings

Adaptor, Parflare, PVDF Transition

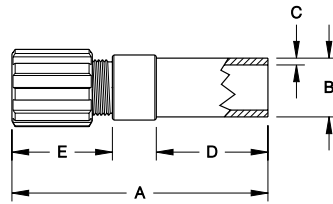

Part Number	Parflare Size	Parbond Size	Orifice		A		B		C		D		E	
			inch	mm	inch	mm	inch	mm	inch	mm	inch	mm	inch	mm
BA-4F20MM-PVDF	1/4	20 mm	0.13	3.30	3.38	85.85	0.79	20.07	0.08	1.91	1.49	37.85	1.24	31.50
BA-4F25MM-PVDF	1/4	25 mm	0.13	3.30	3.40	86.36	0.99	25.15	0.08	1.91	1.49	37.85	1.24	31.50
BA-6F20MM-PVDF	3/8	20 mm	0.25	6.35	3.40	86.36	0.79	20.07	0.08	1.91	1.49	37.85	1.26	32.00
BA-6F25MM-PVDF	3/8	25 mm	0.25	6.35	3.40	86.36	0.98	24.89	0.07	1.78	1.49	37.85	1.26	32.00
BA-8F20MM-PVDF	1/2	20 mm	0.38	9.65	3.49	88.65	0.79	20.07	0.08	1.91	1.49	37.85	1.35	34.29
BA-8F25MM-PVDF	1/2	25 mm	0.38	9.65	3.51	89.15	0.98	24.89	0.07	1.78	1.49	37.85	1.35	34.29
BA-8F32MM-PVDF	1/2	32 mm	0.38	9.65	3.53	89.66	1.26	32.00	0.10	2.41	1.49	37.85	1.40	35.56
BA-12F20MM-PVDF	3/4	20 mm	0.63	16.00	3.67	93.22	0.79	20.07	0.08	1.91	1.49	37.85	1.50	38.10
BA-12F25MM-PVDF	3/4	25 mm	0.63	16.00	3.68	93.47	0.98	24.89	0.07	1.78	1.49	37.85	1.53	38.86
BA-12F32MM-PVDF	3/4	32 mm	0.63	16.00	3.66	92.96	1.26	32.00	0.10	2.41	1.49	37.85	1.53	38.86
BA-12F40MM-PVDF	3/4	40 mm	0.63	16.00	3.68	93.47	1.58	40.13	0.10	2.41	1.49	37.85	1.54	39.12
BA-16F25MM-PVDF	1	25 mm	0.88	22.35	3.88	98.55	0.98	24.89	0.07	1.78	1.49	37.85	1.72	43.69
BA-16F32MM-PVDF	1	32 mm	0.88	22.35	3.86	98.04	1.26	32.00	0.10	2.41	1.49	37.85	1.73	43.94
BA-16F40MM-PVDF	1	40 mm	0.88	22.35	3.86	98.04	1.57	39.88	0.09	2.29	1.49	37.85	1.73	43.94

Elbow Connector, Parflare

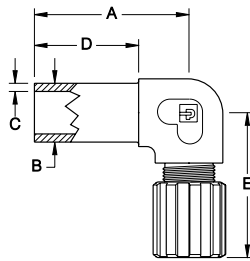

Part Number	Parflare Size	Parbond Size	Orifice		A		B		C		D		E	
			inch	mm	inch	mm	inch	mm	inch	mm	inch	mm	inch	mm
BE-4F4	1/4	1/4	0.13	3.30	1.08	27.43	0.54	13.72	0.08	1.97	0.56	14.22	1.69	42.93
BE-6F4	3/8	1/4	0.25	6.35	1.09	27.69	0.55	13.97	0.09	2.29	0.56	14.22	1.84	46.74
BE-8F8	1/2	1/2	0.38	9.65	2.21	56.13	0.84	21.34	0.10	2.59	1.49	37.85	2.09	53.09
BE-8F12	1/2	3/4	0.38	9.65	2.19	55.63	1.05	26.67	0.11	2.79	1.48	37.59	2.03	51.56
BE-12F8	3/4	1/2	0.63	16.00	2.21	56.13	0.84	21.34	0.12	3.05	1.48	37.59	2.03	51.56
BE-12F12	3/4	3/4	0.63	16.00	2.20	55.88	1.05	26.67	0.11	2.79	1.48	37.59	2.12	53.85
BE-16F16	1	1	0.88	22.35	2.45	62.23	1.32	33.53	0.14	3.56	1.48	37.59	2.12	53.85

Elbow Connector, Redi-flare

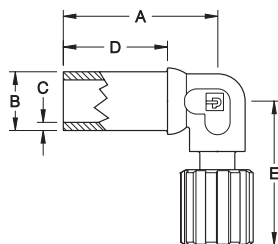

Part Number	Redi-flare Size	Parbond Size	Orifice		A		B		C		D		E	
			inch	mm	inch	mm	inch	mm	inch	mm	inch	mm	inch	mm
BE-88RF	1/2	1/2	0.38	9.65	2.21	56.13	0.84	21.34	0.11	2.67	1.49	37.85	2.03	51.56
BE-1212RF	3/4	3/4	0.63	16.00	2.35	59.69	1.05	26.67	0.12	3.05	1.50	38.10	2.42	61.47
BE-1612RF	3/4	1	0.63	16.00	2.45	62.23	1.32	33.53	0.14	3.56	1.50	38.10	2.53	64.26

Parbond PFA Fusible Pipe Fittings

Elbow Connector, 90°

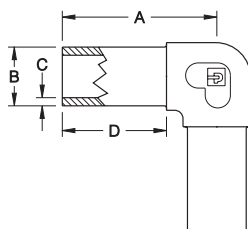

Part Number	Parbond Size	A		B		C		D	
		inch	mm	inch	mm	inch	mm	inch	mm
BE-4	1/4	1.09	27.69	0.55	13.87	0.08	2.08	0.57	14.48
BE-8	1/2	2.19	55.63	0.84	21.41	0.11	2.67	1.48	37.59
BE-12	3/4	2.36	59.94	1.06	26.90	0.11	2.86	1.49	37.85
BE-16	1	2.45	62.23	1.32	33.45	0.13	3.30	1.49	37.85
BE-32	2	3.29	83.57	2.39	60.66	0.16	4.04	1.50	38.10

Elbow Connector, 45°

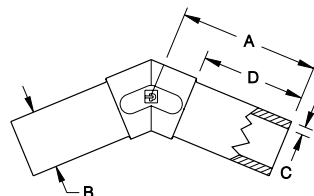

Part Number	Parbond Size	A		B		C		D	
		inch	mm	inch	mm	inch	mm	inch	mm
BE-445	1/4	0.94	23.88	0.54	13.77	0.08	1.98	0.69	17.53
BE-845	1/2	2.00	50.80	0.85	21.49	0.11	2.68	1.50	38.10
BE-1245	3/4	1.98	50.29	1.05	26.75	0.11	2.77	1.49	37.85
BE-1645	1	1.94	49.28	1.32	33.58	0.13	3.40	1.48	37.59
BE-3245	2	2.49	63.25	2.39	60.81	0.17	4.25	1.48	37.59

Tee Connector, Male Pipe

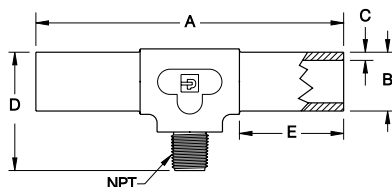

Part Number	MNPT Size	Parbond Size	Orifice		A		B		C		D		E	
			inch	mm	inch	mm	inch	mm	inch	mm	inch	mm	inch	mm
BT-884MP	1/4	1/2	0.29	7.37	4.44	112.78	0.85	21.54	0.11	2.74	1.27	32.26	1.50	38.10

Tee Connector, Parflare

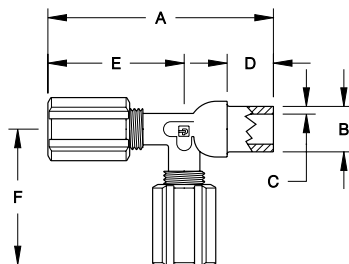

Part Number	Parflare Size	Parbond Size	Orifice		A		B		C		D		E		F	
			inch	mm	inch	mm	inch	mm	inch	mm	inch	mm	inch	mm	inch	mm
BT-4F44F	1/4	1/4	0.13	3.30	2.82	71.63	0.55	13.97	0.08	2.11	0.56	14.22	1.70	43.18	1.72	43.69

Parbond PFA Fusible Pipe Fittings

Tee Connector, Redi-flare

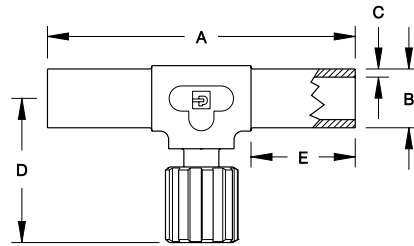

Part Number	Parflare Size	Parbond Size	Orifice		A		B		C		D		E	
			inch	mm	inch	mm	inch	mm	inch	mm	inch	mm	inch	mm
BT-888RF	1/2	1/2	0.25	6.35	4.41	112.01	0.84	21.34	0.11	2.67	2.00	50.80	1.50	38.10
BT-121212RF	3/4	3/4	0.63	16.00	4.67	118.62	1.05	26.67	0.11	2.79	2.20	55.88	1.49	37.85

Tee Connector

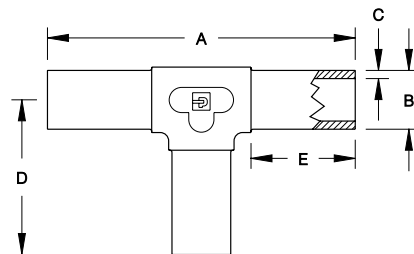

Part Number	Parbond Size	A		B		C		D		E	
		inch	mm	inch	mm	inch	mm	inch	mm	inch	mm
BT-4	1/4	2.17	55.12	0.55	13.97	0.08	2.11	1.10	27.94	0.56	14.22
BT-8	1/2	4.39	111.51	0.84	21.41	0.11	2.68	2.18	55.37	1.49	37.85
BT-12	3/4	4.69	119.13	1.06	26.92	0.11	2.86	2.34	59.44	1.50	38.10
BT-16	1	4.87	123.70	1.31	33.15	0.12	2.98	2.43	61.72	1.48	37.59
BT-32	2	6.58	167.13	2.39	60.58	0.16	3.99	3.29	83.57	1.50	38.10

Tee Connector Reducer

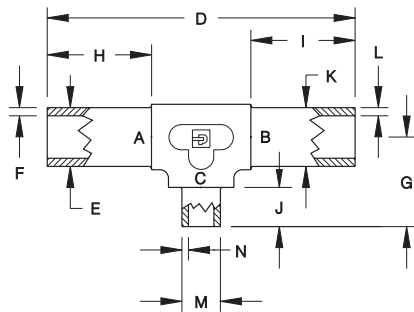

Part Number	A	B	C	D		E		F		G		H		I		J		K		L		M		N	
	Parbond Size	inch	mm	inch	mm	inch	mm	inch	mm	inch	mm	inch	mm	inch	mm	inch	mm	inch	mm	inch	mm	inch	mm	inch	mm
BTR-848	1/2	1/4	1/2	3.47	88.1	0.84	21.3	0.10	2.6	2.19	55.6	1.49	37.8	0.56	14.2	1.49	37.8	0.56	14.2	0.09	2.3	0.84	21.3	0.10	2.5
BTR-884	1/2	1/2	1/4	4.42	112	0.84	21.3	0.12	3.0	1.28	32.5	1.49	37.8	1.49	37.8	0.56	14.2	0.84	21.3	0.10	2.5	0.56	14.2	0.09	2.3
BTR-12412	3/4	1/4	3/4	3.75	95.3	1.05	26.7	0.11	2.8	2.34	59.4	1.50	38.1	0.56	14.2	1.50	38.1	0.56	14.2	0.10	2.5	1.05	26.7	0.11	2.8
BTR-12812	3/4	1/2	3/4	4.67	119	1.05	26.7	0.12	3.0	2.34	59.4	1.50	38.1	1.49	37.8	1.50	38.1	0.84	21.3	0.10	2.5	1.05	26.7	0.11	2.8
BTR-12124	3/4	3/4	1/4	4.70	119	1.05	26.7	0.11	2.8	1.42	36.1	1.50	38.1	1.50	38.1	0.56	14.2	1.05	26.7	0.11	2.8	0.56	14.2	0.09	2.3
BTR-12128	3/4	3/4	1/2	4.66	118	1.05	26.7	0.11	2.8	2.33	59.2	1.50	38.1	1.50	38.1	1.49	37.8	1.05	26.7	0.11	2.8	0.84	21.3	0.10	2.5
BTR-121216	3/4	3/4	1	4.90	124	1.05	26.7	0.11	2.8	2.47	62.7	1.50	38.1	1.50	38.1	1.50	38.1	1.05	26.7	0.11	2.8	1.32	33.5	0.14	3.6
BTR-16164	1	1	1/4	4.88	124	1.32	33.5	0.13	3.4	1.53	38.9	1.50	38.1	1.50	38.1	0.56	14.2	1.32	33.5	0.14	3.6	0.56	14.2	0.09	2.3
BTR-16168	1	1	1/2	4.91	124	1.32	33.5	0.14	3.6	2.46	62.5	1.50	38.1	1.50	38.1	1.49	37.8	1.32	33.5	0.14	3.6	0.84	21.3	0.10	2.5

Product Overview

The Pipe Fittings are ideally suited for any ultra-pure or corrosive chemical application. The all PFA design yields maximum corrosion resistance. The fittings are available in a wide variety of configurations and sizes. Please consult factory for other available configurations, materials, and custom assemblies.



Features

PFA body manufactured from virgin High Purity PFA materials.

Numerous configurations.

Benefits

Less surface particulates resulting in cleaner operation.

Reduced system complexity and cost.

Specifications

Materials of Construction:

Wetted Surfaces - PFA

Pressure Ranges:

[See Pressure/Temperature Chart below.](#)

Temperature Ranges:

[See Pressure/Temperature Chart below.](#)

Assembly Procedure

1. Apply PTFE tape to male NPT threads starting one thread back from end of fitting and in direction of threads to conform tape to shape of threads.
 - a. Use 3 ½ to 4 wraps of tape when assembling to fluoropolymer material.
 - b. Use 4 to 5 wraps of tape when assembling to material other than fluoropolymer.
2. Thread the fitting onto the mating component until hand-tight.
3. Using a wrench, tighten fitting about 4 turns past hand-tight.

Torque

Fitting Size	in/lbs	Newtons/m
1/8"	7.0	.79
1/4"	16	1.81
3/8"	23	2.60
1/2"	30	3.39
3/4"	54	6.10
1"	78	8.81

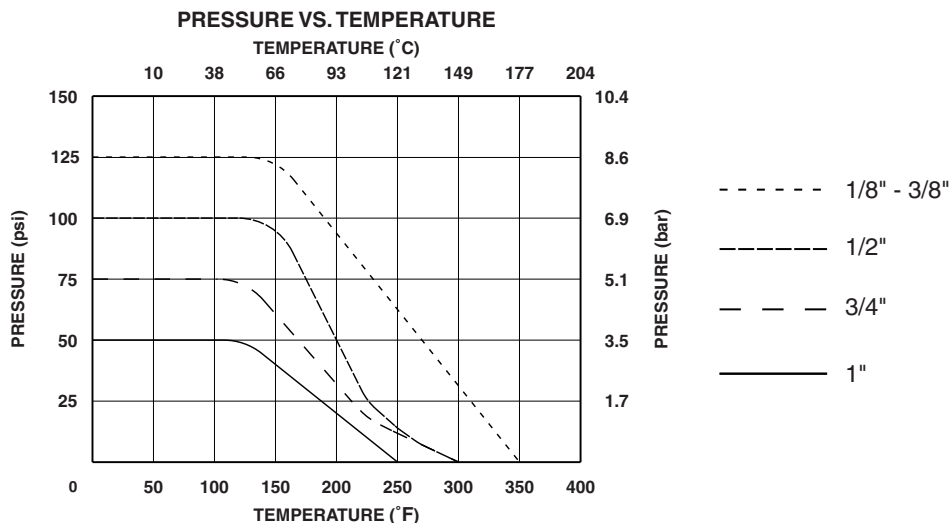

PFA Pipe Fittings

Plug

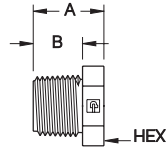

Part Number	NPT Size	A		B		Hex Size
		inch	mm	inch	mm	
P-2-P	1/8	0.84	21.33	0.55	13.97	1/2
P-4-P	1/4	0.84	21.33	0.55	13.97	5/8
P-6-P	3/8	0.84	21.33	0.55	13.97	13/16
P-8-P	1/2	0.94	23.88	0.65	16.51	15/16
P-12-P	3/4	0.94	23.88	0.65	16.51	1 3/16
P-16-P	1	1.11	28.19	0.82	20.83	1 7/16

Nipple

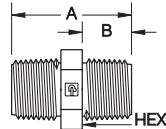

Part Number	NPT Size	Orifice		A		B		Hex Size
		inch	mm	inch	mm	inch	mm	
PN-2-P	1/8	0.20	5.10	1.39	35.30	0.55	13.97	1/2
PN-4-P	1/4	0.29	7.36	1.39	35.30	0.55	13.97	5/8
PN-6-P	3/8	0.41	10.41	1.39	35.30	0.55	13.97	13/16
PN-8-P	1/2	0.53	13.46	1.61	40.89	0.66	16.76	15/16
PN-12-P	3/4	0.65	16.51	1.61	40.89	0.66	16.76	1 3/16
PN-16-P	1	0.96	24.38	1.97	50.04	0.84	21.33	1 7/16

Nipple Reducer

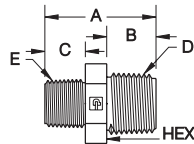

Part Number	D NPT Size	E NPT Size	Orifice		A		B		C		Hex Size
			inch	mm	inch	mm	inch	mm	inch	mm	
PNR-42-P	1/4	1/8	0.20	5.08	1.34	34.04	0.55	13.97	0.55	13.97	5/8
PNR-64-P	3/8	1/4	0.28	7.11	1.38	35.05	0.55	13.97	0.55	13.97	13/16
PNR-84-P	1/2	1/4	0.28	7.11	1.50	38.10	0.65	10.51	0.55	13.97	13/16
PNR-86-P	1/2	3/8	0.41	10.41	1.50	38.10	0.65	10.51	0.55	13.97	15/16
PNR-128-P	3/4	1/2	0.53	13.46	1.60	40.64	0.65	10.51	0.65	10.51	1 3/16
PNR-1612-P	1	3/4	0.65	16.51	1.78	45.21	0.84	21.33	0.65	10.51	1 7/16

Bushing

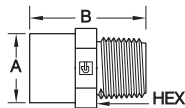

Part Number	FNPT Size	MNPT Size	Orifice		A		B		Hex Size
			inch	mm	inch	mm	inch	mm	
PB-24-P	1/8	1/4	0.25	6.35	0.63	16.00	1.40	35.56	5/8
PB-26-P	1/8	3/8	0.25	6.35	0.63	26.00	1.40	35.56	3/4
PB-42-P	1/4	1/8	0.25	6.35	0.75	19.05	1.40	35.56	3/4
PB-44-P	1/4	1/4	0.25	6.35	0.75	19.05	1.40	35.56	3/4
PB-46-P	1/4	3/8	0.31	7.87	0.75	19.05	1.40	35.56	3/4
PB-48-P	1/4	1/2	0.31	7.87	0.75	19.05	1.50	38.10	15/16
PB-412-P	1/4	3/4	0.31	7.87	0.75	19.05	1.50	38.10	1 3/16
PB-64-P	3/8	1/4	0.25	6.35	0.94	23.87	1.40	35.56	15/16
PB-68-P	3/8	1/2	0.42	10.67	0.94	23.87	1.50	38.10	15/16
PB-612-P	3/8	3/4	0.42	10.67	0.94	23.87	1.50	38.10	1 3/16
PB-84-P	1/2	1/4	0.25	6.35	1.12	28.45	1.50	38.10	1 3/16
PB-812-P	1/2	3/4	0.53	13.46	1.12	28.45	1.63	41.40	1 3/16
PB-816-P	1/2	1	0.53	13.46	1.12	28.45	1.94	49.28	1 3/8
PB-128-P	3/4	1/2	0.53	13.46	1.41	35.81	1.63	41.40	1 3/16
PB-1212-P	3/4	3/4	0.65	16.51	1.41	35.81	1.63	41.40	1 3/16
PB-1216-P	3/4	1	0.75	19.05	1.41	35.81	1.80	45.72	1 7/16

Coupling

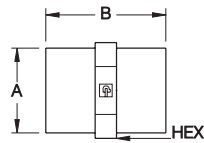

Part Number	NPT Size	Orifice		A		B		Hex Size
		inch	mm	inch	mm	inch	mm	
PC-2-P	1/8	0.25	6.35	0.63	16.00	1.40	35.56	5/8
PC-4-P	1/4	0.31	7.87	0.75	19.05	1.40	35.56	3/4
PC-6-P	3/8	0.42	10.67	0.95	24.13	1.40	35.56	15/16
PC-8-P	1/2	0.57	14.48	1.15	29.21	1.64	41.66	1 1/8
PC-12-P	3/4	0.75	19.05	1.41	35.81	1.64	41.66	1 7/16

Female Reducer

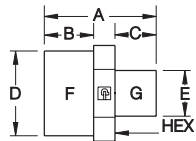

Part Number	F NPT Size	G NPT Size	Orifice		A		B		C		D		E		Hex Size
			inch	mm	inch	mm	inch	mm	inch	mm	inch	mm	inch	mm	
PFR-42-P	1/4	1/8	.25	6.35	1.41	35.81	.56	14.22	.55	13.97	.75	19.05	.62	15.75	3/4
PFR-82-P	1/2	1/8	.25	6.35	1.50	38.10	.66	16.76	.55	13.97	1.14	28.96	.62	15.75	1 1/8

Elbow

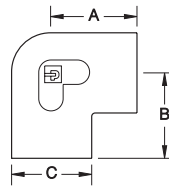

Part Number	NPT Size	Orifice		A		B		C	
		inch	mm	inch	mm	inch	mm	inch	mm
PE-2-P	1/8	0.25	6.35	0.83	21.08	0.83	21.08	0.63	16.00
PE-4-P	1/4	0.31	7.87	0.97	24.64	0.97	24.64	0.75	19.05
PE-6-P	3/8	0.42	10.67	0.97	24.64	0.97	24.64	0.94	23.88
PE-8-P	1/2	0.56	14.22	1.24	31.50	1.24	31.50	1.16	29.46
PE-12-P	3/4	0.75	19.05	1.32	33.53	1.32	33.53	1.44	36.58

Street Elbow

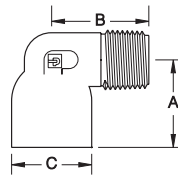

Part Number	FNPT Size	MNPT Size	Orifice		A		B		C	
			inch	mm	inch	mm	inch	mm	inch	mm
PSE-22-P	1/8	1/8	0.20	5.08	0.84	21.33	1.25	31.75	0.63	16.00
PSE-44-P	1/4	1/4	0.29	7.36	0.99	25.15	1.25	31.75	0.77	19.56
PSE-66-P	3/8	3/8	0.42	10.67	0.99	25.15	1.25	31.75	0.94	23.87
PSE-88-P	1/2	1/2	0.54	13.71	1.25	31.75	1.25	31.75	1.15	29.21
PSE-1212-P	3/4	3/4	0.66	16.76	1.38	35.05	1.74	44.20	1.35	34.29

Tee

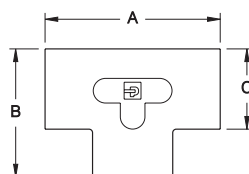

Part Number	NPT Size	Orifice		A		B		C	
		inch	mm	inch	mm	inch	mm	inch	mm
PT-2-P	1/8	0.25	6.25	1.68	42.16	1.15	29.21	0.63	16.00
PT-4-P	1/4	0.35	8.89	1.97	50.03	1.35	34.29	0.75	19.05
PT-6-P	3/8	0.44	11.17	1.97	50.03	1.46	37.08	0.94	23.87
PT-8-P	1/2	0.56	14.22	2.48	62.99	1.80	45.72	1.14	28.95
PT-12-P	3/4	0.75	19.05	2.61	66.29	2.02	51.31	1.42	36.07
PT-16-P	1	1.00	25.40	3.22	81.79	2.46	62.48	1.70	43.18

NW Nut Wrench

Product Overview

The NW Nut Wrench is designed to aid in the assembly of the Parflare and Pargrip fittings.

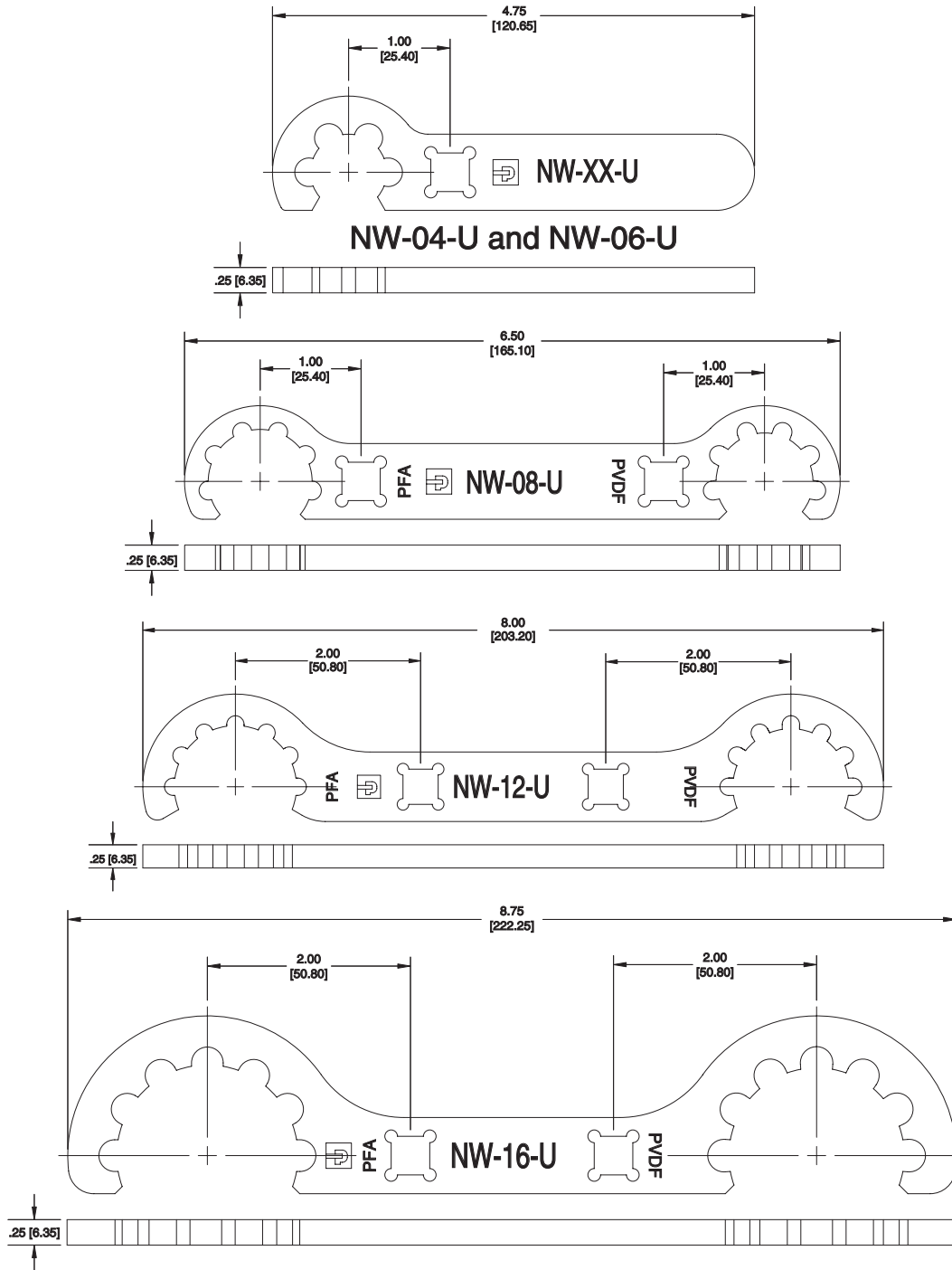

Model No.	Fitting Nut Size	Nut Material	Fitting Style
NW-04-U	1/4"	PVDF & PFA	Parflare & Pargrip
NW-06-U	3/8"	PVDF & PFA	Parflare & Pargrip
NW-08-U	1/2"	PVDF & PFA	Parflare & Pargrip
NW-12-U	3/4"	PVDF & PFA	Parflare & Pargrip
NW-16-U	1"	PVDF & PFA	Parflare & Pargrip

Standard Parflare fitting has PVDF nut. Standard Pargrip fitting has PFA nut.

Product Overview

Flare end connections have been established as the preferred connection in high purity and corrosive applications. Because poorly flared Fluoropolymer tubing can cause leaks and costly downtime, Partek recommends the heat flaring procedure. In this procedure HG Heat Gun, MFT Manual Flaring Tools and TCTR Tube Cutters are utilized.

Flaring and Assembly Procedure 1/4" - 1 1/4" Tubing Sizes*

1. Cut tubing evenly using a tube cutter:
TCTR-1 for 1/8" - 1/2"
TCTR-2 for 1/8" - 3/4"
TCTR-3 for 1/8" - 1 1/2"
2. For PVDF or PFA nuts slip small end over tubing. For HT nut assemblies slip small end of nut & small end of gripper over tubing.
3. Using the HG-1** Heat Gun on high setting, hold the end of tubing approximately 1/2" from gun and rotate tubing slowly until a fine whitish line appears around tube. Alternately, tubing can be heated for a timed period [corresponding to Table 1](#).
4. Remove tubing from heat source and immediately push over the appropriate flaring mandrel until end of tubing reaches the mandrel stop shoulder.
5. Maintain tubing on mandrel together until cool. [Refer to Table 1](#) for appropriate cooling times.
6. Allow tubing to cool on mandrel for an additional 2 to 3 minutes. Alternately the tubing can be assembled as per step 7 below immediately completing step 5 above.
7. Push flared tubing end over desired fitting body until it stops. Make sure that gap between end of tubing and fitting body shoulder is not more than .125" (3.2mm).
8. For PVDF or PFA nuts tighten onto fitting body as [per Table 1](#). For HT nut assemblies tighten onto fitting body [per Table 1](#). Once desired temperature has been reached, re-tighten [per Table 1](#).

* HT nut assemblies are for 1/4" - 1" sizes only.

** HG-1 Specifications

Temperature Range: 750° - 1000° F (400° - 540° C)

Voltage: 120 VAC

Cycle: 60 HZ

Amperage: 14.5 amps

Wattage: 1,740 watts

Average Air Velocity: 3,000 FPM at ambient

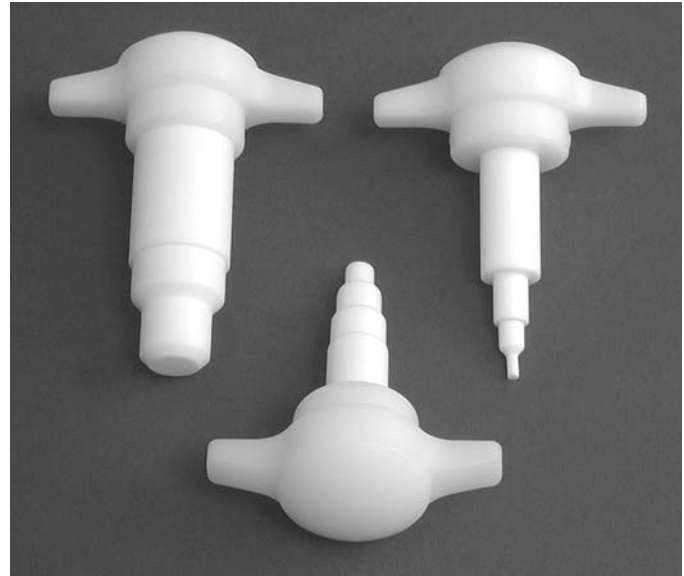

Model No.	Tubing OD	Tubing ID
MFT-U	1/4" - 1"	see below
MFT-04	1/4"	5/32"
MFT-06	3/8"	1/4"
MFT-08	1/2"	3/8"
MFT-12	3/4"	5/8"
MFT-16	1"	7/8"
MFT-20	1 1/4"	1.10"

Table 1

Fitting Size	1/4"	3/8"	1/2"	3/4"	1"	1 1/4"
Heating time (sec.) for PFA Tubing	15	25	25	25	25	25
Holding time on mandrel	20	20	20	20	25	25
Additional cooling time (min.)	2	2	3	3	3	3
PVDF & PFA Nuts minimum tightening torque (inch lbs./Nm)	5 / .6	8 / .9	11 / 1.2	14 / 1.6	30 / 3.4	75 / 8.4
HT Nut Assemblies minimum tightening torque (inch lbs/Nm)	14 / 1.6	14 / 1.6	18 / 2.0	18 / 2.0	50 / 5.7	NA

FG Electronic Flare Gun

Product Overview

The FG Electronic Flare Gun is designed to flare PFA and HP PFA tubing perfectly, every time. It is ideal for connections that need to be made in clean rooms, in equipment cabinets or other hard to reach places where conventional flaring tools are not suitable. The complete process of heating, flaring and cooling is all contained within the gun. Compact, portable and easy to use, the gun is offered in 5 sizes, 1/4" to 1".



Features

Tubing snaps into jaws of the flare gun.

Indicator lights on the flare gun guide the operator during the heating, flaring and cooling operations.

Compact and portable, it is offered in 5 sizes, 1/4" to 1".

Benefits

Holds tubing so that mandrel travel depth is consistent.

Perfect flare every time reduces potential leaks and downtime.

Ideal for working in areas where space is limited. Faster set up of new equipment is possible.

Specifications

Heating Cycle: 380° F to 420° F (193° C to 216° C) for 17-20 sec.

Cooling Cycle: 45-60 sec.

Voltage: 120 VAC

Cycle: 60 HZ

Amperage: 2 amps

Wattage: 240 watts

Types of Tubing: Catalog 4150

Model No.	Tubing OD	Tubing ID
FG-1-4C	1/4"	5/32"
FG-1-6C	3/8"	1/4"
FG-1-8C	1/2"	3/8"
FG-1-12C	3/4"	5/8"
FG-1-16C	1"	7/8"

*C Denotes Flare gun is shipped in carrying case

Model No.	Flare guns included in Kit				
FG-1K-2	FG-1-12	FG-1-16			
FG-1K-3	FG-1-4	FG-1-6	FG-1-8		
FG-1K-4	FG-1-4	FG-1-6	FG-1-8	FG-1-12	
FG-1K-5	FG-1-4	FG-1-6	FG-1-8	FG-1-12	FG-1-16

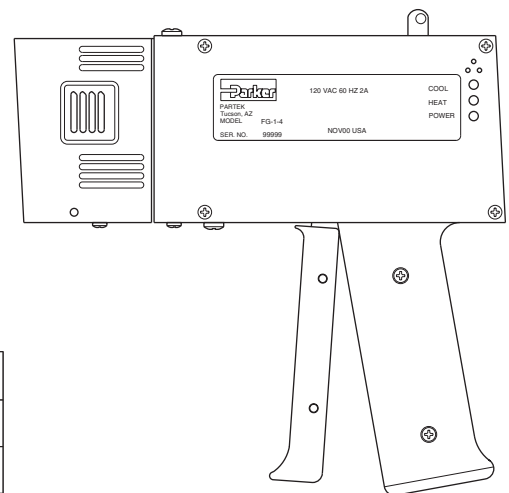

Tube Flaring

There are many advantages to making connections with flared fittings. The flared fitting is the cleanest breakable connection available because of its low dead volume. This decreases the chance for particle entrapment in the fitting. From the cross section it is evident that the tube is supported on the inside. This prevents the tubing from ovalizing or bottoming out, therefore allowing the flared fitting to perform well in vibration and side loading applications.

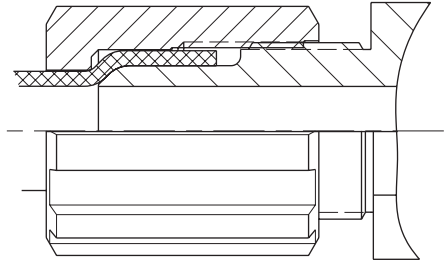

Flaring and Assembly Procedure 1/4" - 1" Tubing Sizes

1. Cut tubing evenly using a tube cutter:
TCTR-1 for 1/8" - 1/2"
TCTR-2 for 1/8" - 3/4"
TCTR-3 for 1/8" - 1 1/2"
2. For PVDF or PFA nuts slip small end over tubing. For HT nut assemblies slip small end of nut and small end of gripper over tubing.
3. Holding the flare gun, push lever to the most forward position.
4. Squeeze trigger 12 to 14 times to reset the mandrel to the start position.
5. Move top lever to the most rear position.
6. Insert the correct sized tubing. [See page 42.](#)
7. Click trigger until resistance is lost.
8. Plug in tool and put the lever in the center position.
9. After 30 seconds you will hear a beep.
10. Ratchet the trigger until resistance is felt and note the amber LED coming on to indicate that cooling has begun.
11. After this light goes out, move the lever into the most forward position.
12. Remove the flared tubing.
13. Push flared tubing end over desired fitting body until it stops. Make sure that gap between end of tubing and fitting body shoulder is not more than .125" (3.2mm).
14. For PVDF or PFA nuts tighten onto fitting body as [per Table 1 below](#). For HT nut assemblies tighten onto fitting body [per Table 1](#). Once desired temperature has been reached, re-tighten [per Table 1](#).

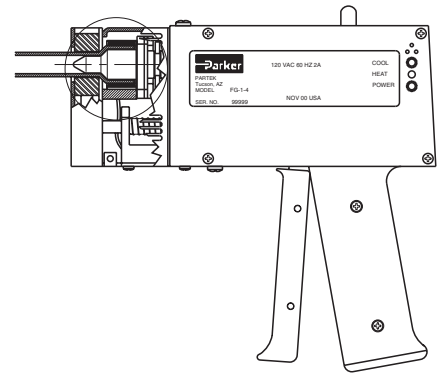
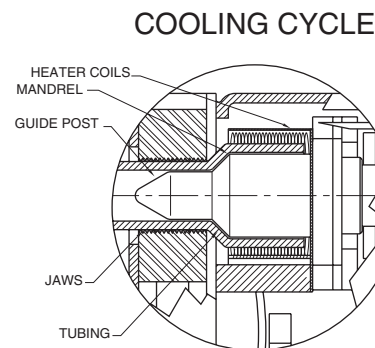
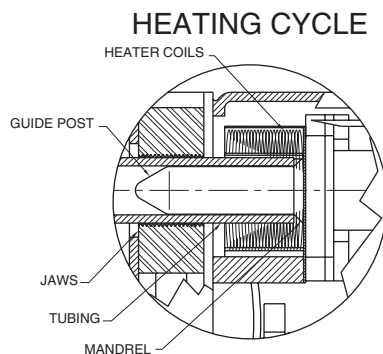

Table 1

Fitting Size	1/4"	3/8"	1/2"	3/4"	1"
PVDF & PFA Nuts minimum tightening torque (inch lbs./Nm)	5 / .6	8 / .9	11 / 1.2	14 / 1.6	30 / 3.4
HT Nut Assemblies minimum tightening torque (inch lbs./Nm)	14 / 1.6	14 / 1.6	18 / 2.0	18 / 2.0	50 / 5.7



The tubing is inserted into the gun, and the jaws bite down on the tubing. The gun heats the tubing to the ideal temperature and alerts the user when the cycle is complete. At this time the flare mandrel is pushed into the tubing in the flare position where it is held for the cooling cycle

Notes

Offer of Sale

The items described in this document and other documents or descriptions provided by Parker Hannifin Corporation, its subsidiaries and its authorized distributors are hereby offered for sale at prices to be established by Parker Hannifin Corporation, its subsidiaries and its authorized distributors. This offer and its acceptance by any customer ("Buyer") shall be governed by all of the following Terms and Conditions. Buyer's order for any such items, when communicated to Parker Hannifin Corporation, its subsidiary or an authorized distributor ("Seller") verbally or in writing, shall constitute acceptance of this offer.

1. Terms and Conditions of Sale: All descriptions, quotations, proposals, offers, acknowledgments, acceptances and sales of Seller's products are subject to and shall be governed exclusively by the terms and conditions stated herein. Buyer's acceptance of any offer to sell is limited to these terms and conditions. Any terms or conditions in addition to, or inconsistent with those stated herein, proposed by Buyer in any acceptance of an offer by Seller, are hereby objected to. No such additional, different or inconsistent terms and conditions shall become part of the contract between Buyer and Seller unless expressly accepted in writing by Seller. Seller's acceptance of any offer to purchase by Buyer is expressly conditional upon Buyer's assent to all the terms and conditions stated herein, including any terms in addition to, or inconsistent with those contained in Buyer's offer. Acceptance of Seller's products shall in all events constitute such assent.

2. Payment: Payment shall be made by Buyer net 30 days from the date of delivery of the items purchased hereunder. Amounts not timely paid shall bear interest at the maximum rate permitted by law for each month or portion thereof that the Buyer is late in making payment. Any claims by Buyer for omissions or shortages in a shipment shall be waived unless Seller receives notice thereof within 30 days after Buyer's receipt of the shipment.

3. Delivery: Unless otherwise provided on the face hereof, delivery shall be made F.O.B. Seller's plant. Regardless of the method of delivery, however, risk of loss shall pass to Buyer upon Seller's delivery to a carrier. Any delivery dates shown are approximate only and Seller shall have no liability for any delays in delivery.

4. Warranty: Seller warrants that the items sold hereunder shall be free from defects in material or workmanship for a period of 18 months from date of shipment from Parker Hannifin Corporation. **THIS WARRANTY COMPRISES THE SOLE AND ENTIRE WARRANTY PERTAINING TO ITEMS PROVIDED HEREUNDER. SELLER MAKES NO OTHER WARRANTY, GUARANTEE, OR REPRESENTATION OF ANY KIND WHATSOEVER. ALL OTHER WARRANTIES, INCLUDING BUT NOT LIMITED TO, MERCHANTABILITY AND FITNESS FOR PURPOSE, WHETHER EXPRESS, IMPLIED, OR ARISING BY OPERATION OF LAW, TRADE USAGE, OR COURSE OF DEALING ARE HEREBY DISCLAIMED.**

NOTWITHSTANDING THE FOREGOING, THERE ARE NO WARRANTIES WHATSOEVER ON ITEMS BUILT OR ACQUIRED WHOLLY OR PARTIALLY, TO BUYER'S DESIGNS OR SPECIFICATIONS.

5. Limitation Of Remedy: SELLER'S LIABILITY ARISING FROM OR IN ANY WAY CONNECTED WITH THE ITEMS SOLD OR THIS CONTRACT SHALL BE LIMITED EXCLUSIVELY TO REPAIR OR REPLACEMENT OF THE ITEMS SOLD OR REFUND OF THE PURCHASE PRICE PAID BY BUYER, AT SELLER'S SOLE OPTION. IN NO EVENT SHALL SELLER BE LIABLE FOR ANY INCIDENTAL, CONSEQUENTIAL OR SPECIAL DAMAGES OF ANY KIND OR NATURE WHATSOEVER, INCLUDING BUT NOT LIMITED TO LOST PROFITS ARISING FROM OR IN ANY WAY CONNECTED WITH THIS AGREEMENT OR ITEMS SOLD HEREUNDER, WHETHER ALLEGED TO ARISE FROM BREACH OF CONTRACT, EXPRESS OR IMPLIED WARRANTY, OR IN TORT, INCLUDING WITHOUT LIMITATION, NEGLIGENCE, FAILURE TO WARN OR STRICT LIABILITY.

6. Changes, Reschedules and Cancellations: Buyer may request to modify the designs or specifications for the items sold hereunder as well as the quantities and delivery dates thereof, or may request to cancel all or part of this order, however, no such requested modification or cancellation shall become part of the contract between Buyer and Seller unless accepted by Seller in a written amendment to this Agreement. Acceptance of any such requested modification or cancellation shall be at Seller's discretion, and shall be upon such terms and conditions as Seller may require.

7. Special Tooling: A tooling charge may be imposed for any special tooling, including without limitation, dies, fixtures, molds and patterns, acquired to manufacture items sold pursuant to this contract. Such special tooling shall be and remain Seller's property notwithstanding payment of any charges by Buyer. In no event will Buyer acquire any interest in apparatus belonging to Seller which is utilized in the notwithstanding any charges paid by Buyer. Unless otherwise agreed, Seller shall have the right to alter, discard or otherwise dispose of any special tooling or other property in its sole discretion at any time.

8. Buyer's Property: Any designs, tools, patterns, materials, drawings, confidential information or equipment furnished by Buyer or any other items which become Buyer's property, may be considered obsolete and may be destroyed by Seller after two (2) consecutive years have elapsed without Buyer placing an order for the items which are manufactured using such property, Seller shall not be responsible for any loss or damage to such property while it is in Seller's possession or control.

9. Taxes: Unless otherwise indicated on the face hereof, all prices and charges are exclusive of excise, sales, use, property, occupational or like taxes which may be imposed by any taxing authority upon the manufacture, sale or delivery of the items sold hereunder. If any such taxes must be paid by Seller or if Seller is liable for the collection of such tax, the amount thereof shall be in addition to the amounts for the items sold. Buyer agrees to pay all such taxes or to reimburse Seller therefore upon receipt of its invoice. If Buyer claims exemption from any sales, use or other tax imposed by any taxing authority, Buyer shall save Seller harmless from and against any such tax, together with any interest or penalties thereon which may be assessed if the items are held to be taxable.

10. Indemnity For Infringement of Intellectual Property Rights: Seller shall have no liability for infringement of any patents, trademarks, copyrights, trade dress, trade secrets or similar rights except as provided in this Part 10. Seller will defend and indemnify Buyer against allegations of infringement of U.S. Patents, U.S. Trademarks, copyrights, trade dress and trade secrets (hereinafter 'Intellectual Property Rights'). Seller will defend at its expense and will pay the cost of any settlement or damages awarded in an action brought against Buyer based on an allegation that an item sold pursuant to this contract infringes the Intellectual Property Rights of a third party. Seller's obligation to defend and indemnify Buyer is contingent on Buyer notifying Seller within ten (10) days after Buyer becomes aware of such allegations of infringement, and Seller having sole control over the defense of any allegations or actions including all negotiations for settlement or compromise. If an item sold hereunder is subject to a claim that it infringes the Intellectual Property Rights of a third party, Seller may, at its sole expense and option, procure for Buyer the right to continue using said item, replace or modify said item so as to make it noninfringing, or offer to accept return of said item and return the purchase price less a reasonable allowance for depreciation. Notwithstanding the foregoing, Seller shall have no liability for claims of infringement based on information provided by Buyer, or directed to items delivered hereunder for which the designs are specified in whole or part by Buyer, or infringements resulting from the modification, combination or use in a system of any item sold hereunder. The foregoing provisions of this Part 10 shall constitute Seller's sole and exclusive liability and Buyer's sole and exclusive remedy for infringement of Intellectual Property Rights.

If a claim is based on information provided by Buyer or if the design for an item delivered hereunder is specified in whole or in part by Buyer, Buyer shall defend and indemnify Seller for all costs, expenses or judgments resulting from any claim that such item infringes any patent, trademark, copyright, trade dress, trade secret or any similar right.

11. Force Majeure: Seller does not assume the risk of and shall not be liable for delay or failure to perform any of Seller's obligations by reason of circumstances beyond the reasonable control of Seller (hereinafter 'Events of Force Majeure'). Events of Force Majeure shall include without limitation, accidents, acts of God, strikes or labor disputes, acts, laws, rules or regulations of any government or government agency, fires, floods, delays or failures in delivery of carriers or suppliers, shortages of materials and any other cause beyond Seller's control.

12. Entire Agreement/Governing Law: The terms and conditions set forth herein, together with any amendments, modifications and any different terms or conditions expressly accepted by Seller in writing, shall constitute the entire Agreement concerning the items sold, and there are no oral or other representations or agreements which pertain thereto. This Agreement shall be governed in all respects by the law of the State of Ohio. No actions arising out of the sale of the items sold hereunder or this Agreement may be brought by either party more than two (2) years after the cause of action accrues.

9/91-P





Parker Hannifin Corporation
6035 Parkland Blvd.
Cleveland, Ohio 44124-4141
Telephone: (216) 896-3000
Fax: (216) 896-4000
www.parker.com

Parker Hannifin Corporation

About Parker Hannifin Corporation

Parker Hannifin is a leading global motion-control company dedicated to delivering premier customer service. A Fortune 500 corporation listed on the New York Stock Exchange (PH), our components and systems comprise over 1,400 product lines that control motion in some 1,000 industrial and aerospace markets. Parker is the only manufacturer to offer its customers a choice of hydraulic, pneumatic, and electromechanical motion-control solutions. Our Company has the largest distribution network in its field, with over 7,500 distributors serving nearly 400,000 customers worldwide.

Parker's Charter

To be a leading worldwide manufacturer of components and systems for the builders and users of durable goods. More specifically, we will design, market and manufacture products controlling motion, flow and pressure. We will achieve profitable growth through premier customer service.

Product Information

North American customers seeking product information, the location of a nearby distributor, or repair services will receive prompt attention by calling the Parker Product Information Center at our toll-free number: 1-800-C-PARKER (1-800-272-7537). In Europe, call 00800-C-PARKER-H (00800-2727-5374).

The Aerospace Group is a leader in the development, design, manufacture and servicing of control systems and components for aerospace and related high-technology markets, while achieving growth through premier customer service.



The Climate & Industrial Controls Group designs, manufactures and markets system-control and fluid-handling components and systems to refrigeration, air-conditioning and industrial customers worldwide.

The Fluid Connectors Group designs, manufactures and markets rigid and flexible connectors, and associated products used in pneumatic and fluid systems.

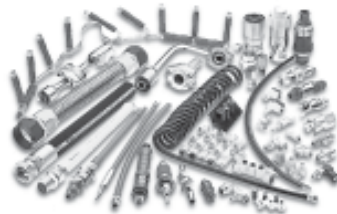

The Seal Group designs, manufactures and distributes industrial and commercial sealing devices and related products by providing superior quality and total customer satisfaction.

The Hydraulics Group designs, produces and markets a full spectrum of hydraulic components and systems to builders and users of industrial and mobile machinery and equipment.



The Filtration Group designs, manufactures and markets quality filtration and clarification products, providing customers with the best value, quality, technical support, and global availability.

The Automation Group is a leading supplier of pneumatic and electromechanical components and systems to automation customers worldwide.



The Instrumentation Group is a global leader in the design, manufacture and distribution of high-quality critical flow components for worldwide process instrumentation, ultra-high-purity, medical and analytical applications.

Parker Hannifin Corporation
Partek Operation
7075 East Southpoint Road
Tucson, AZ 85706 USA
Tel: (520) 574-2600
Fax: (520) 574-2700
<http://www.parker.com/partek>

Catalog 4181
R03/04